



僑隆機械有限公司

AVALONG TECHNOLOGY CO., LTD

CHYAU LONG MACHINERY CO., LTD

43444 台中市龍井區三港路326巷18號

No.18, Ln. 326, Sangang Rd., Longjing Dist., Taichung City, 43444, Taiwan.

TEL: 886-4-26396611

website: www.avalong.com

FAX: 886-4-26393989

E-mail: mixer@avalong.com

僑隆機械

TAIWAN

- ✘ 整廠造粒輸送設備
- ✘ 全自動計量輸送設備
(粉體、液體、粒子、碎片)
- ✘ 高速混合機與各式攪拌機系列
- ✘ 磨粉機系列
- ✘ 搓粒機系列
- ✘ 實驗機系列
- ✘ 特殊機型與附屬設備

Turnkey for Pelletizing & Compounding System
Fully-auto Metering & Conveying System
(Solids & Liquids)
High Speed Mixer & Blender Series
Pulverizer Series
Agglomerator Series
Laboratory Mixer Series
Customized Machineries & Auxiliary Equipment



amtri veritas
hulley road,
macclesfield
cheshire SK10 2NE
england

獲歐洲國家共同認證
及經濟部各項專利

Registration Number
0463

PRINT 201801004



公司沿革與組織規模

僑隆機械有限公司成立於1977年，在當時塑膠工業快速起飛時，本公司積極研發製造出高品質，高效率之高速混合攪拌機配合立、臥式冷卻攪拌機及自動輸送系統，所適用之範圍有PVC塑膠原料，化工原料、化妝品、食品類、玻璃纖維、鐵氧磁體(Ferrite)等。

並自1995年開始研發磨粉機、搓粒機、製粒機、自動計量、自動供料等機械，完全配合客戶需求量身製做，為客戶創造更高附加價值之產品。近幾年更進一步為客戶做電線電纜造粒整廠機械輸出之流程規劃與製造，適用於PVC整廠造粒，PVC塑膠管，PVC門板。本公司並嚴格控管整個生產製程，免費提供客戶試車，做銷售前最好的服務。銷售實績至目前已行銷世界35個國家以上。也承蒙世界級大廠對我們品質的肯定，例美國GE公司、德國REHAU、法國ATOFINA及台灣南亞台塑等各大公司。

Company History & Organization

Chyau Long (Avalong) has been established in Taiwan since 1977. Plastic industry in Taiwan has grown rapidly since then. We design and develop high quality and efficiency High-Speed Mixer, Vertical Cooler, Horizontal Cooler and Semi-Automatic Conveying System suitable for PVC plastic raw materials, chemical materials, cosmetic, food, glass, ferrite, etc.

In order to meet various users' needs, in 1995 we started R&D on Pulverizers, Granulating Machines, Automatic Metering Equipment etc. We increase the profit for our customers by means of technology and meet customers' needs. In recent years, we took a step further in designing complete line of PVC (Cable) granulation, PVC pipe and PVC windows. Under strict production control, we take care of each process parts and offer customer free test on machines before procurement. With great support from our customers, we are able to make global sales to over 35 countries worldwide.

Major global companies including GE PLASTICS CHINA LTD (U.S.A.), REHAU PETE LTD.(Germany), TEIJIN CHEMICALS LTD(Japan), ATOFINA LTD (France) and FORMOSA GROUP (Taiwan, China, U.S.A.) etc.

品質形象與遠景

僑隆公司所生產的高速混合攪拌設備是目前in Taiwan業界公認為高品質的象徵，以滿足用戶的個別需求為第一，並不斷開發更好的機器，來為客戶量身訂做適宜的產品，並且贏得客戶的信任，於1993年得到中華民國國產精良機械金龍獎，1994年得到中華經貿文化促進會績優金牌獎評審委員會特優獎，更於1996年得到中華民國金品獎。

在產品是企業生存的命脈基礎下，相繼取得多國專利，已建立產品國際市場競爭力，為滿足國際市場對品質保證的要求，於2000年1月取得歐盟國家CE認證，且將來，一定再研發提供更優良的機器設備給不同的客戶。同時，在充分的滿足客戶對環境保護與節省人力的需求下，協助客戶提升生產自動化的能力，達成無人化之現代工廠，是僑隆要積極實踐的目標。

Product Quality & Long-Term Goals

In Taiwan, Chyau Long's (Avalong) high speed mixer equipment is renowned for its high quality image. It is always our first priority to fulfill the demands of each individual. By constantly developing better products, we are able to help each customer make the best machines in accordance with their needs and to win their confidence and trust. In 1993, Chyau Long (Avalong) was awarded the R.O.C. Golden Dragon Award. In the following year, the R.O.C. Special Excellence Award, and in 1996 the R.O.C. Golden Quality Award.

The products make up the lifeblood of any manufacturing enterprise, and by obtaining a succession of patents, Chyau Long (Avalong) has been able to achieve a high level of competitiveness in the international market. In order to satisfy worldwide Quality Assurance standards, Chyau Long (Avalong) has achieved the European CE Quality Assurance certification in 2000. It is our hope that this will aid us in our goal of bringing excellent machines and equipment to an increasing number of global customers. It is Chyau Long's (Avalong) long term aim not only to continue to improve environmental and labor saving conditions, but to assist our customers to increase the level of automation in their factories to achieve the ultimate goal of zero-manpower.



- Innovative Technology
- Professional Design
- High Quality
- High Efficiency
- Energy Saving
- Sincere Service



公司團隊
AVALONG TEAM



鄧白氏中小企業菁英獎
D&B TOP 1000 SMES ELITE AWARD



業務部團隊
SALES TEAM



每周周會
WEEKLY MEETING



控制系統
CONTROL SYSTEM



製造部
PRODUCTION DEPARTMENT





COMPANY



TRADEMARK CERTIFICATES & COPYRIGHTED PRODUCT SERIES

公司認證與專利&客戶產品系列 05

MATERIAL HANDLING



AUTOMATIC METERING & CONVEYING SYSTEM

PVC自動秤料輸送系統 07

SEMI-AUTOMATIC CONVEYING SYSTEM

半自動輸送系統 09

MIXER 混合機系列



F HIGH SPEED MIXER

F高速混合機 11

MA/MB VERTICAL COOLING MIXER

MA/MB立式冷卻攪拌機 12

HV HORIZONTAL COOLING MIXER

HV臥式冷卻攪拌機 13

HU HORIZONTAL MIXER

HU臥式冷熱攪拌機 15

H/K/D HORIZONTAL MIXER

H/K/D臥式混合機 16

MM VERTICAL MIXER

MM立式混合機 17

Z ROUND-BARREL MIXER

Z圓筒式混合機 18

RH ROTATIONAL MIXER

RH滾筒式混合機 19

LABORATORY MIXER FOR LIQUID AND POWDER

液體與粉體混合實驗機 20

SPECIAL DESIGNED MIXER

特殊機型一臥式混合機&包水路攪拌機 21



AUTOMATION

FULLY AUTOMATIC MIXING、WEIGHING & CONVEYING SYSTEM

整廠混合自動計量輸送系統 23

AUTOMATIC METERING, MIXING & CHAIN CONVEYING SYSTEM

整廠粉液體全自動計量、高速混合與管鍊輸送系統 25

FULLY AUTOMATIC MIXING、WEIGHING & CONVEYING SYSTEM

全自動混合計量輸送系統 27

FULLY AUTOMATED PRODUCTION SYSTEM

整廠自動化生產系統 29



PELLETIZING



TWIN SCREW PELLETIZING SYSTEM

雙螺桿式造粒整廠設備 31

PVC COMPOUNDING SYSTEM

PVC造粒整廠設備 33

SINGLE SCREW PVC PELLETIZING SYSTEM

單螺桿式造粒整廠設備 35

PVC、EVA、PP/PE + CaCO₃、LSNH PVC+NBR、TPR COMPOUNDING SYSTEM

PVC、EVA、PP/PE + CaCO₃、LSNH PVC+NBR、TPR造粒整廠設備 37

WOOD PLASTIC COMPOSITE AUTOMATED PRODUCTION SYSTEM

WPC仿木材整廠自動化生產系統 39

TPE AUTOMATIC COMPOUNDING LINE (UNDER WATER CUTTING)

TPE水中造粒整廠自動化生產系統 41



AUXILIARIES

AUXILIARIES

附屬設備 43

SPECIAL

CUSTOMISED DESIGN

特殊客製化設計 44

PULVERIZER



G TYPE COMPLETE INSTALLATION OF PULVERIZER

G磨粉機整套設備 45

CRUSHING, PULVERIZING ENTIRE WRAP FLOW EQUIPMENT

粉碎&磨粉機整套設備 49

SPECIAL DESIGN OF PULVERIZER SERIES

特殊客製化磨粉機系列 51

GR TYPE COMPLETE INSTALLATION OF ROTATING PULVERIZER

GR旋轉式磨粉機整套設備 55

GJ TYPE HAMMERING PULVERIZER

GJ錘擺式磨粉機 57



AGGLOMERATOR

AGGLOMERATOR SERIES

搓粒機系列 59

SAMPLE

GRANULATED MAIERIALS

搓粒樣品圖示 61

PULVERIZED MAIERIALS

磨粉樣品圖示 62

EXHIBITION DOCUMENTARY

EXHIBITIONS WORLD WIDE

世界各國展覽實況 64

SALES REFERENCE

SALES REFERENCE WORLD WIDE

世界各國銷售實績 65



▲電線電纜 PVC CABLE



▲PVC管 PVC PIPE



▲塑膠鞋系列 PVC PLASTIC SHOES SERIES



▲PVC 管件 PVC FITTING



▲仿木材 WOOD PLASTIC COMPOSITE PRODUCT

MATERIAL HANDLING

PVC自動秤料輸送系統

AUTOMATIC METERING & CONVEYING SYSTEM

特性

適用於各種小包裝太空包粉體運送，入料輕鬆，不用將原料搬到混合機架台上面加料，粉塵不外洩，有儲料功能，節省人力、時間，降低成本，提高產量30%，是一套具環保又經濟的輸送系統，並深受塑膠業界愛用。

FEATURES

In addition to storing barrel for Vacuum packages and storage function, this unit automatically handles powder package conveying, featuring easy operation, and avoiding the need to carry and add raw material at Mixer operation platform. It also prevents dust leakage saves labor and time, and helps reduce processing cost. An environment-friendly and economic conveyor system that can increase the productivity by 30%, this is the ideal model for the plastic industry.

▼ PVC & CaCO₃太空包兩種物料同時計量輸送至混合設備
PVC & CaCO₃ SIMULTANEOUS WEIGHING CONVEYING SYSTEM FOR 2 JUMBO BAGS.



▲太空包架 JUMBO BAGS CRANE SET



- 1 太空包秤料輸送
AUTOMATIC METERING & CONVEYING SYSTEM FOR JUMBO BAG
- 2 小包人工入料槽
FEEDING STORAGE TANK FOR SMALL BAG
- 3 魯式鼓風機
ROOTS BLOWER
- 4 真空過濾儲料桶
VACUUM BARREL
- 5 自動秤油系統
AUTOMATIC OIL SCALING SYSTEM

- 6 高速混合機
HIGH SPEED MIXER
- 7 MB 型立式冷卻攪拌機
MB TYPE VERTICAL COOLING MIXER
- 8 操作架台
OPERATION PLATFORM
- 9 墊高台
ELEVATED PLATFORM
- 10 控制箱
CONTROL BOX



MATERIAL HANDLING

混合機系列一半自動輸送系統



SEMI-AUTOMATIC CONVEYING SYSTEM

特性

適用於各種小包裝太空包粉體運送，入料輕鬆，不用將原料搬到混合機架台上面加料，粉塵不外洩，有儲料功能，節省人力、時間，降低成本，提高產量30%，是一套具環保又經濟的輸送系統，並深受塑膠業界愛用。

FEATURES

In addition to storing barrel for Vacuum packages and storage function, this unit automatically handles powder package conveying, featuring easy operation, and avoiding the need to carry and add raw material at Mixer operation platform. It also prevents dust leakage saves labor and time, and helps reduce processing cost. An environment-friendly and economic conveyor system that can increase the productivity by 30%, this is the ideal model for the plastic industry.

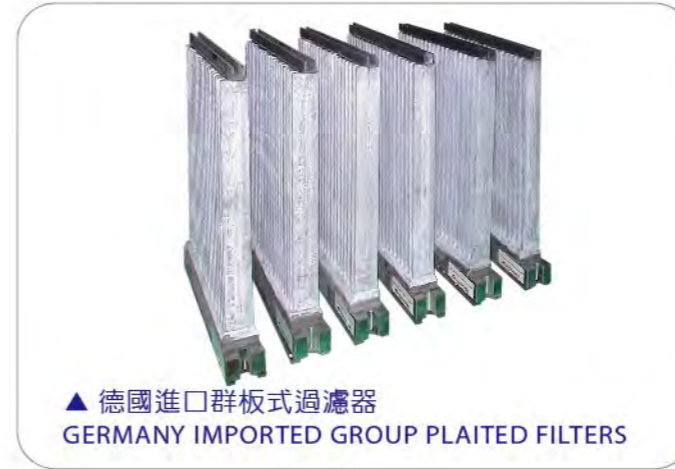

▲ 德國進口群板式過濾器
GERMANY IMPORTED GROUP PLAIED FILTERS



▲ SKD-11 耐磨刀具 (選購品)
ABRASION-PROOF BLADES(OPTIONAL)

▲ 底部厚度20mm. BOTTOM THICKNESS 20mm

中間桶
VACUUM BARREL

德國進口群板式過濾器
GERMANY IMPORTED GROUP
PLAIED FILTERS

魯式鼓風機
ROOTS BLOWER

CL-F 高速混合機
HIGH SPEED MIXER

中間桶
VACUUM BARREL

CL-F 高速混合機
HIGH SPEED MIXER

小包人工入料槽
SMALL BAG FEEDING STORAGE TANK

CL-MB 立式冷卻攪拌機
VERTICAL COOLING MIXER

小包人工入料槽
SMALL BAG FEEDING STORAGE TANK

CL-HV 圓筒水平式攪拌機
HORIZONTAL COOLING MIXER

MIXER 高速混合機

CL-F TYPE HIGH SPEED MIXER

特性

- CL-FA：採用固定轉速AC馬達驅動，適用於一般物料混合。
- CL-FB：採用兩段速度變極AC馬達驅動，適於量大之物料混合，物料混合均勻。
- CL-FC：採用變頻無段變速AC馬達驅動，可隨物料特性之不同而做速度調整，並可節省電力10%~20%。

FEATURES

- CL-FA：Adopts fixed rev.speed AC motor drive suitable for general material mixing.
- CL-FB：Adopts pole change 2 step speed AC motor drive suitable for large volume material mixing.
- CL-FC：Adopts stepless variable speed inverter AC motor drive where mixing speed can be adjusted against different materials.



CL-F Specifications 規格

型式 Model	全容量 Tank Capacity	物料入量 Feeding Capacity	混合重量 Mixing Weight	動力 Power	機械尺寸 Machine Size	機械重量 Machine Weight
CL-FA25	28L	13~15L	5~8kg	10HP · 6P	1500x500x1200mm	350kg
CL-FA50	55L	25~30L	15kg	30HP · 6P	1650x620x1300mm	700kg
CL-FA100	130L	60~70L	35kg	50HP · 6P	1800x750x1600mm	1300kg
CL-FA200	250L	120~150L	75kg	60HP · 6P	2300x900x1900mm	1800kg
CL-FA300	350L	180~230L	120kg	100HP · 6P	2700x1100x2200mm	2500kg
CL-FA400	420L	230~300L	150kg	125HP · 6P	2800x1200x2300mm	3400kg
CL-FA500	550L	300~360L	180kg	125HP · 6P	2800x1200x2300mm	3600kg
CL-FB25	28L	13~15L	5~8kg	15/7.5HP · 4/8P	1500x500x1200mm	350kg
CL-FB50	55L	25~30L	15kg	30/15HP · 4/8P	1650x620x1300mm	700kg
CL-FB100	130L	60~70L	35kg	40/20HP · 4/8P	1800x750x1600mm	1300kg
CL-FB200	250L	120~150L	75kg	60/30HP · 4/8P	2300x900x1900mm	1800kg
CL-FB300	350L	180~230L	120kg	100/50HP · 4/8P	2700x1100x2200mm	2500kg
CL-FB400	420L	230~300L	150kg	150/75HP · 4/8P	2800x1200x2300mm	3400kg
CL-FB500	550L	300~360L	180kg	150/75HP · 4/8P	2800x1200x2300mm	3600kg
CL-FC10	15L	5~7L	3~5kg	10HP無段變速Inverter	1200x400x1000mm	200kg
CL-FC25	28L	10~15L	5~8kg	15HP無段變速Inverter	1500x500x1200mm	350kg
CL-FC50	55L	25~30L	20kg	30HP無段變速Inverter	1650x620x1300mm	700kg
CL-FC100	130L	60~70L	40kg	50HP無段變速Inverter	1800x750x1600mm	1300kg
CL-FC200	250L	120~150L	75kg	60HP無段變速Inverter	2300x900x1900mm	1800kg
CL-FC300	350L	180~230L	120kg	100HP無段變速Inverter	2700x1100x2200mm	2500kg
CL-FC400	420L	230~300L	150kg	125HP無段變速Inverter	2800x1200x2300mm	3400kg
CL-FC500	550L	300~360L	180kg	125HP無段變速Inverter	2800x1200x2300mm	3600kg
CL-FC750	800L	450~540L	270kg	200HP無段變速Inverter	3300x1350x2450mm	4300kg
CL-FC1000	1050L	600~720L	360kg	250HP無段變速Inverter	3760x1600x2600mm	5600kg
CL-FC1200	1200L	700~900L	420kg	300HP無段變速Inverter	3850x1700x2450mm	6000kg
CL-FC1500	1500L	900~1050L	530kg	400HP無段變速Inverter	3850x1700x3010mm	6500kg

混合重量視物料而定 Compound Weight Depends on Materials

MIXER 立式冷卻攪拌機

CL-MA/MB TYPE VERTICAL COOLING MIXER



4片
4 Plates

▲ MB型內部導流通水板
加大冷卻面積用(標準)
MB TYPE INNER PLATE WATER GUIDING
TO ENLARGE COOLING AREA.(STANDARD)



▲ 保溫保冷層(選購品)
INSULATION LAYER (OPTIONAL)

CL-MA/MB Specifications 規格

型式 Model	全容量 Tank Capacity	物料入量 Feeding Capacity	混合重量 Mixing Weight	動力 Power	機械尺寸 Machine Size	機械重量 Machine Weight
CL-MA200	200L	70~140L	80kg	15HP · 4P	1700x900x1500mm	1000kg
CL-MA400	400L	150~300L	150kg	20HP · 4P	1850x1050x1600mm	1200kg
CL-MA600	600L	200~400L	240kg	25HP · 4P	2050x1300x1750mm	1500kg
CL-MA1000	1000L	350~700L	360kg	30HP · 4P	2450x1600x1900mm	2500kg
CL-MA1500	1500L	600~1000L	540kg	40HP · 4P	2600x1800x2000mm	3000kg
CL-MA2000	2000L	800~1400L	720kg	50HP · 4P	2800x1900x2100mm	4000kg
CL-MA3000	3000L	1400~2100L	1080kg	60HP · 4P	3500x2100x2200mm	4500kg
CL-MB400	400L	150~300L	150kg	20HP · 4P	1850x1050x1600mm	1200kg
CL-MB600	600L	200~400L	240kg	25HP · 4P	2050x1300x1750mm	1500kg
CL-MB1000	1000L	350~700L	360kg	30HP · 4P	2450x1600x1900mm	2500kg
CL-MB1500	1500L	600~1000L	540kg	40HP · 4P	2600x1800x2000mm	3000kg
CL-MB2000	2000L	800~1400L	720kg	50HP · 4P	2800x1900x2100mm	4000kg
CL-MB3000	3000L	1400~2100L	1080kg	60HP · 4P	3500x2100x2200mm	4500kg
CL-MB3500	3500L	1800~2450L	1225kg	60HP · 4P	3500x2100x2200mm	4800kg

混合重量視物料而定 Compound Weight Depends on Materials



▲ 本公司會針對客戶物料特性設計
適合之攪拌葉片
CUSTOMIZED BLADES ACCORDING TO
MATERIAL CHARACTERISTICS



▲ 4層刀耐磨具
4-LAYER ABRASION PROOF BLADES

MIXER 混合機系列-高速混合機

HIGH SPEED MIXER

特性

- 具有品質好、效率高、混合均勻、分散性佳的特點。
- 清潔簡單方便、容量大、混合與冷卻攪拌快速。
- 操作簡單容易、維護保養簡易安全且成本低。

FEATURES

- High quality, high efficiency, uniform mixing and good dispersion.
- Big Volume, big capacity, high speed mixing and cooling.
- Easy to maintain, easy to operate, high safety, save more electricity and labor cost.



▲ PVC 硬質膠布
RIGID PVC SHEET

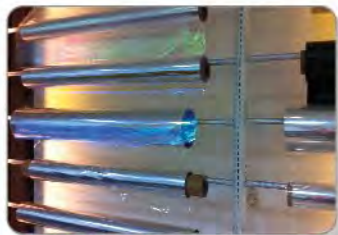

▲ PVC 軟質膠布
SOFT PVC SHEET



▲ 保鮮膜
SARAN WRAP



CL-HV 臥式冷卻攪拌機
HORIZONTAL COOLING MIXER

CL-F 高速混合機
HIGH SPEED MIXER



MIXER 混合機系列-臥式冷卻攪拌機

CL-HV HORIZONTAL COOLING MIXER

特性

傳動馬達與減速機採立式斜置方式節省空間；採用固定轉速AC馬達與減速機驅動，適用於一般物料混合。兩端軸封採壓縮空氣清淨設計。

FEATURES

Vertical installation of motor & reducer saves space; Adopts fixed rev. Speed AC motor drive suitable for general material mixing. Two sides of mechanical seal adopts compressed air purge seal design.

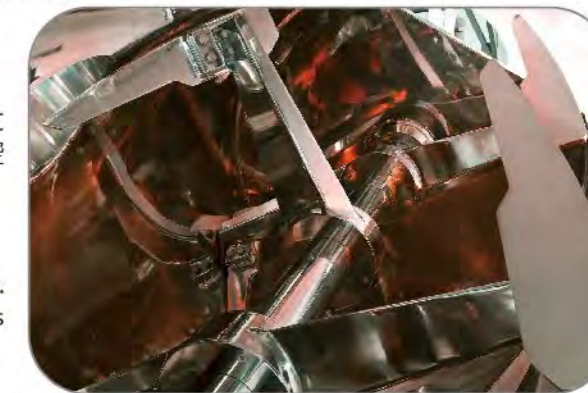

▲ 攪拌機內部刀葉 INTERNAL MIXING BLADE



CL-HV Specifications 規格

型式 Model	全容量 Tank Capacity	主機動力 Main Power	機械尺寸 Machine Size	機械重量 Machine Weight
CL-HV1000	1000L	20HP · 4P	2600x1020x1750mm	1500kg
CL-HV1500	1500L	20HP · 4P	2150x1200x2650mm	2850kg
CL-HV2500	2500L	30HP · 4P	2300x1450x3500mm	3250kg
CL-HV3500	3500L	40HP · 4P	2500x1550x3600mm	3500kg
CL-HV5000	5000L	60HP · 4P	4000x2500x2200mm	5500kg

本表僅供參考實際依顧客需求設計而定
This chart is only for reference. The actual design will be determined upon customers request.

MIXER

混合機系列-臥式冷熱攪拌機

CL-HU HORIZONTAL MIXER

特性

傳動馬達與減速機採立式斜置方式節省空間；採用固定轉速AC馬達與減速機驅動，操作安全效率高，適用於一般物料混合。兩端軸封採壓縮空氣清淨設計。本機可選用冷卻水循環的冷卻攪拌或熱煤油加熱循環的加熱攪拌，依客戶需求設計製作。

FEATURES

Motor & reducer installed vertically to save space. Adopts fixed rev. speed AC motor drive suitable for general material mixing. Air purged shaft seal design. This machine can be coupled optionally with either cooling mixing by cold water circulation, or with hot mixing by kerosene-oil-heated circulation, to be designated by the customer.



▲ 攪拌機內部葉片
INTERNAL MIXING BLADE



▲ 冷卻交換器
HEAT EXCHANGER



臥式冷熱攪拌機 HORIZONTAL COOLING & HEATING MIXER

CL-HU Specifications 規格

型式 Model	全容量 Tank Capacity	主機動力 Main Power	機械尺寸 Machine Size	機械重量 Machine Weight
CL-HU1500	1500L	20HP · 4P	2250x1350x2700mm	2950kg
CL-HU2500	2500L	30HP · 4P	2850x1550x3600mm	3350kg
CL-HU3500	3500L	40HP · 4P	2900x1600x3700mm	3650kg
CL-HU4000	4000L	50HP · 4P	2950x1800x3800mm	3900kg
CL-HU6000	6000L	75HP · 4P	3250x2150x3900mm	4350kg
CL-HU10000	10000L	100HP · 4P	3500x2320x3980mm	5360kg

本表僅供參考實際依顧客須求設計而定
This chart is only for reference. The actual design will be determined upon customers request.



MIXER

混合機系列-臥式混合機

HORIZONTAL MIXER



CL-H 臥式冷卻混合機
HORIZONTAL COOLING MIXER

CL-H Specifications 規格

型式 Model	物料入量 Feeding Capacity	混合重量 Mixing Weight	動力 Power	機械尺寸 Machine Size	機械重量 Machine Weight
CL-H100	35~70L	40kg	5HP · 4P	1800x650x1250mm	450kg
CL-H200	70~140L	80kg	5HP · 4P	2040x850x1450mm	750kg
CL-H400	150~300L	150kg	7.5HP · 4P	2200x900x1500mm	900kg
CL-H600	200~400L	240kg	10HP · 4P	2430x950x1750mm	1100kg
CL-H1000	350~700L	360kg	15HP · 4P	2600x1060x1730mm	1300kg
CL-H1500	500~1000L	540kg	20HP · 4P	2850x1100x1830mm	1700kg
CL-H2000	700~1400L	720kg	25HP · 4P	3150x1150x1950mm	2100kg
CL-H3000	1400~2100L	1080kg	30HP · 4P	3300x1500x2000mm	3000kg
CL-H3500	1800~2450L	1225kg	40HP · 4P	3500x1500x2000mm	3200kg
CL-H4000	2100~2800L	1400kg	40HP · 4P	4000x1500x2500mm	3500kg
CL-H5000	2000~3500L	1750kg	40HP · 4P	4500x1550x2500mm	4000kg

混合重量視物料而定 Compound Weight Depends on Materials

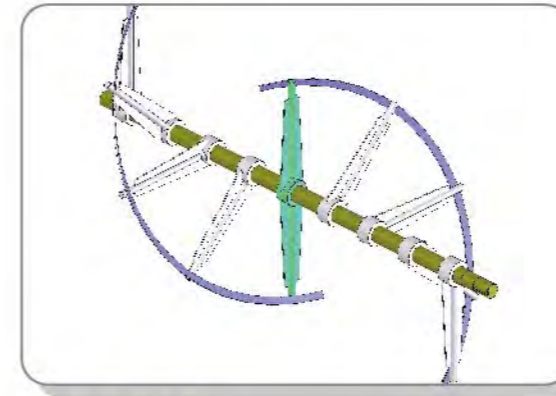

▲ 單帶攪拌軸組
SINGLE RIBBON MIXING BLADE

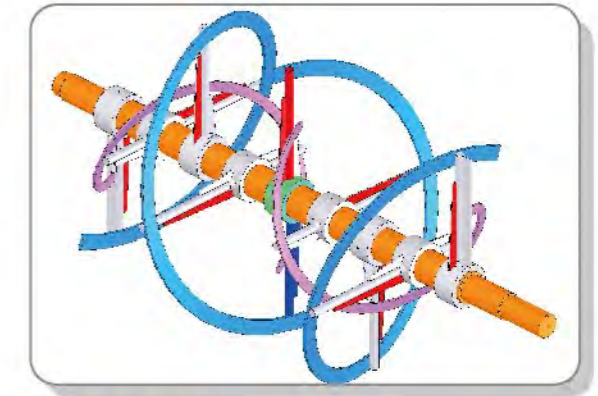

▲ 雙帶攪拌軸組
DOUBLE RIBBON MIXING BLADE

特性

單帶或雙帶攪拌葉由客戶選定，雙帶比單帶攪拌更加均勻。

FEATURES

Single ribbon or double ribbon mixing blade to be designated by the customer; the double ribbon mixing blade can blend the material more evenly.

CL-K Specifications 規格

型式 Model	物料入量 Feeding Capacity	混合重量 Mixing Weight	動力 Power	機械尺寸 Machine Size	機械重量 Machine Weight
CL-K100	35~70L	40kg	5HP · 4P	1800x650x1250mm	450kg
CL-K200	70~140L	80kg	5HP · 4P	2040x850x1450mm	750kg
CL-K400	150~300L	150kg	5HP · 4P	2200x900x1500mm	900kg
CL-K600	200~400L	240kg	7.5HP · 4P	2430x950x1750mm	1100kg
CL-K1000	350~700L	360kg	10HP · 4P	2600x1060x1730mm	1300kg
CL-K1500	500~1000L	540kg	15HP · 4P	2850x1100x1830mm	1700kg
CL-K2000	700~1400L	720kg	20HP · 4P	3150x1150x1950mm	2100kg
CL-K3000	1400~2100L	1080kg	30HP · 6P	3300x1500x2000mm	3000kg
CL-K3500	1800~2450L	1225kg	30HP · 6P	3500x1500x2000mm	3200kg
CL-K4000	2100~2800L	1400kg	40HP · 6P	4000x1500x2500mm	3500kg
CL-K5000	2000~3500L	1750kg	40HP · 6P	4500x1550x2500mm	4000kg

混合重量視物料而定 Compound Weight Depends on Materials

CL-D Specifications 規格

型式 Model	物料入量 Feeding Capacity	混合重量 Mixing Weight	動力 Power	機械尺寸 Machine Size	機械重量 Machine Weight
CL-D100	35~70L	40kg	5HP · 4P	1800x650x1250mm	400kg
CL-D200	70~140L	80kg	5HP · 4P	2040x850x1450mm	750kg
CL-D400	150~300L	150kg	7.5HP · 4P	2200x900x1500mm	900kg
CL-D600	200~400L	240kg	10HP · 4P	2430x950x1650mm	1100kg
CL-D1000	350~700L	360kg	15HP · 4P	2600x1016x1650mm	1300kg
CL-D1500	500~1000L	540kg	20HP · 4P	2850x1100x1830mm	1700kg
CL-D2000	700~1400L	720kg	25HP · 4P	3150x1150x1950mm	2100kg
CL-D3000	1000~2000L	1100kg	30HP · 4P	3360x1250x2200mm	2800kg
CL-D4000	1400~2800L	1500kg	40HP · 6P	4000x1450x2500mm	3650kg
CL-D5000	2000~3500L	2100kg	50HP · 6P	4500x1550x2500mm	4500kg
CL-D6000	3000~4200L	2500kg	60HP · 6P	5200x1700x2500mm	5350kg
CL-D8000	4000~5600L	3500kg	75HP · 6P	5700x1880x2500mm	6250kg
CL-D10000	5000~7000L	4000kg	100HP · 6P	5870x2150x2500mm	7150kg

混合重量視物料而定 Compound Weight Depends on Materials



CL-D 臥式混合機
HORIZONTAL MIXER

MIXER

混合機系列-立式混合機

CL-MM VERTICAL MIXER

特性

- 適於顏色料、化工原料、剎車專用原料，玻璃纖維的擴散，鐵氧磁體(Ferriet)，水泥加砂加顏料，綜合安定劑及粉末冶金之混合等。
- 本機可混合多種物料，並可加裝高轉速馬達及擴散刀具，能使物料在最短時間內混合更加均勻，不積熱，更不會破壞原物料品質。
- 本機特點乃可將混合時之塊狀物加速分散

FEATURES

- Used for mixing dye, chemical raw materials, car brake material, for diffusing fiber glass, ferrite, cement with sand and dye, and for mixing stabilizer and metallurgic powder etc.
- This machine can mix many kinds of material. It is equipped with high speed motor and diffusion tool, which can mix material more evenly in a short time, while causing no residual heat and no damage to the quality of mixed material.
- This machine can diffuse lump material more quickly.



▲ 擴散刀葉
DIFFUSION BLADE



▲ 安定劑 ADDITIVES



▲ 乳化粉 VAE

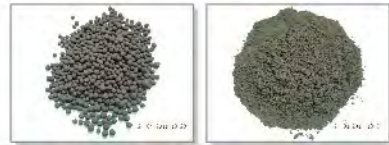

▲ 粉末冶金 METALLURGY POWDER



▲ 酚醛樹脂
PHENOL FORMALDEHYDE RESIN



CL-MM Specifications 規格

型式 Model	物料入量 Feeding Capacity	混合重量 Mixing Weight	主機動力 Main Power	副機動力 Auxiliary Power	機械尺寸 Machine Size	機械重量 Machine Weight
CL-MM100	35~70L	40kg	7.5HP · 4P	10HPx1	1600x800x1400mm	900kg
CL-MM200	70~140L	80kg	10HP · 4P	10HPx1	1700x900x1500mm	1000kg
CL-MM400	150~300L	150kg	15HP · 4P	10HPx1	1850x1050x1600mm	1200kg
CL-MM600	200~400L	240kg	20HP · 4P	10HPx1	2050x1300x1750mm	1500kg
CL-MM1000	350~700L	360kg	25HP · 4P	10HPx2	2450x1600x1900mm	2500kg
CL-MM1500	600~1000L	540kg	30HP · 4P	10HPx2	2600x1800x2000mm	3000kg
CL-MM2000	800~1400L	720kg	40HP · 4P	10HPx2	2800x1900x2100mm	4000kg
CL-MM2500	1400~1600L	870kg	50HP · 4P	10HPx2	3000x2100x2200mm	4500kg
CL-MM3000	1400~2100L	1080kg	60HP · 4P	10HPx2	3500x2100x2200mm	4500kg
CL-MM4000	2000~2800L	1500kg	60HP · 4P	10HPx2	3550x2150x2200mm	4550kg

混合重量視物料而定 Compound Weight Depends on Materials



MIXER

混合機系列-圓筒式混合機

CL-Z ROUND-BARREL MIXER

特性

- 本機可混合多種物料，並可加裝高轉速馬達及擴散刀具，能使物料在最短時間內混合更加均勻，不積熱，更不會破壞原物料品質。
- 本機特點乃將混合時之塊狀物加速分散。
- 適於剎車專用原料混合，玻璃纖維的擴散，鐵氧磁體(Ferriet)、化工原料及紡織纖維之混合等。

FEATURES

- Suitable for many kinds of material. It is specially equipped with high speed motor & diffusion tool, which can mix material more evenly in a short time. No residual heat and no damage to the quality of mixed material.
- This machine can diffuse lump material more quickly.
- Suitable for mixing car-brake material, diffusing fiber glass, ferrite, chemical raw materials and textile fiber etc.



▲ 內部刀葉圖
INTERNAL MIXING BLADE



▲ 剎車皮 BRAKE PADS



▲ 混合前
BEFORE MIXING



▲ 混合後
AFTER MIXING



▲ 混合後
AFTER MIXING



▲ 紡織、纖維混合後成品
TEXTILE AND FIBER PRODUCTS

CL-Z Specifications 規格

型式 Model	物料入量 Feeding Capacity	混合重量 Mixing Weight	主機動力 Main Power	副機動力 Auxiliary Power	機械尺寸 Machine Size	機械重量 Machine Weight
CL-Z60	30~40L	20kg	7.5HP	5HPx1	1600x800x1200mm	550kg
CL-Z200	70~140L	100kg	7.5HP	7.5HPx1	3000x1200x1800mm	1000kg
CL-Z600	200~400L	300kg	15~20HP	10HPx2	3400x1400x2100mm	1500kg
CL-Z800	300~600L	400kg	20~30HP	10HPx2	3800x1550x2200mm	2300kg
CL-Z1000	400~700L	500kg	30~40HP	10HPx2	4100x1600x2250mm	3600kg
CL-Z1500	500~1100L	750kg	40~50HP	10HPx3	4350x1700x2300mm	3200kg
CL-Z2000	700~1400L	1000kg	50~60HP	10HPx3	4650x1850x2400mm	4000kg
CL-Z3000	1100~2100L	1500kg	60~75HP	10HPx4	4900x1950x2500mm	5000kg
CL-Z4000	1400~2800L	2000kg	75~100HP	10HPx4	5200x2100x2700mm	6000kg

混合重量視物料而定 Compound Weight Depends on Materials

MIXER 滾筒式混合機

RH ROTATIONAL MIXER

特性

- 本機適於各種化工原料、塑膠、橡膠原料、工業電子材料、鋰電材料的混合作業。
- 具三層帶式攪拌葉混合的特點，可讓材料混合更加均勻。
- 低馬力、低轉速、不積熱。



FEATURES

- Used for mixing chemical raw materials, plastics, rubber raw materials, industrial electronic materials, lithium materials, etc.
- Adopts three-layer ribbon blending blade to mix materials more evenly.
- Low horsepower, low RPM, and does not accumulate heat.



▲ 淨水器 WATER FILTER



▲ 小量計量(圓桶)
SMALL QUANTITY WEIGHING



▲ 高精密度小量計量
HIGH PRECISION DOSING UNIT

規格 Specifications

型式 Model	全容量 Tank Capacity	主機動力 Main Power	機械尺寸 Machine Size	機械重量 Machine Weight
CL-RH4500	4500L	15HP · 4P	3200x1850x2100mm	3850kg
CL-RH8500	8500L	20HP · 4P	4800x2400x2880xmm	5020kg
CL-RH12000	12000L	30HP · 4P	5350x2400x2900mm	6080kg

本表僅供參考實際依顧客需求設計而定
This chart is only for reference. The actual design will be determined upon customers request.



MIXER 液體與粉體混合實驗機

LABORATORY MIXER FOR LIQUID AND POWDER



▲ CL-FC25 高速混合機
HIGH SPEED MIXER



▲ CL-Z60 圓筒式混合機
MIXER (ROUND-BARREL TYPE)



▲ 振動式袋子混合機
VIBRATION BAG MIXER



▲ 混合實驗機
LABORATORY MIXER



▲ 振動式袋子混合機
VIBRATION BAG MIXER --- SPARE CALDRONS
25L & 50L CAN BE USED INTERCHANGEABLY.



▲ 化妝品 COSMETICS

MIXER

特殊機型—臥式混合機&包水路攪拌機

SPECIAL DESIGNED MIXER



▲ 此機型專為客戶混合抗氧化粉所設計製造,並加裝抽真空設備
THIS MACHINE, INSTALLED WITH VACUUM SYSTEM, IS CUSTOMIZED-DESIGNED FOR MIXING OXIDIZING AGENTS.



▼ 此機型專為客戶混合抗氧化粉所設計製造,並加裝抽真空設備
THIS MACHINE, INSTALLED WITH VACUUM SYSTEM, IS CUSTOMIZED FOR MIXING OXIDIZING AGENTS.



▲ 包冷卻水路攪拌機
WRAPPED COOLING CIRCULATION MIXER



▼ 依客戶需求設計1台熱拌機搭配2台冷拌機使用(1對2)
CUSTOMIZED DESIGNED TO MATCH 1 HOT MIXER TO 2 COLD MIXERS (1 TO 2)

AUTOMATION

整廠系列—混合自動計量輸送

FULLY AUTOMATIC MIXING、WEIGHING & CONVEYING SYSTEM



▲ 火車載運管線輸送至SILO
TRAIN CONVEYING MATERIAL
TO 100-TON SILOS



▲ 100噸SILO
100-TON SILOS



▲ 自動輸送系統
AUTOMATIC CONVEYING SYSTEM



▲ 自動秤油
AUTOMATIC OIL WEIGHING



▲ 自動輸送管線
AUTOMATIC PIPE CONVEYING SYSTEM

① 自動秤料輸送系統
AUTOMATIC METERING & CONVEYING SYSTEM

② 小包人工入料槽
SMALL BAG FEEDING STORAGE TANK

③ 自動秤油系統
AUTOMATIC OIL SCALING SYSTEM

④ 自動投色料設備
INSTALLATIONS OF AUTOMATIC
THROWING COLORS

⑤ 高速混合機
HIGH SPEED MIXER

⑥ 立式冷卻攪拌機
VERTICAL COOLING MIXER

⑦ 儲料桶(自動供料系統)
MATERIAL - OUTPUT BARREL
(AUTOMATIC FEEDING SYSTEM)

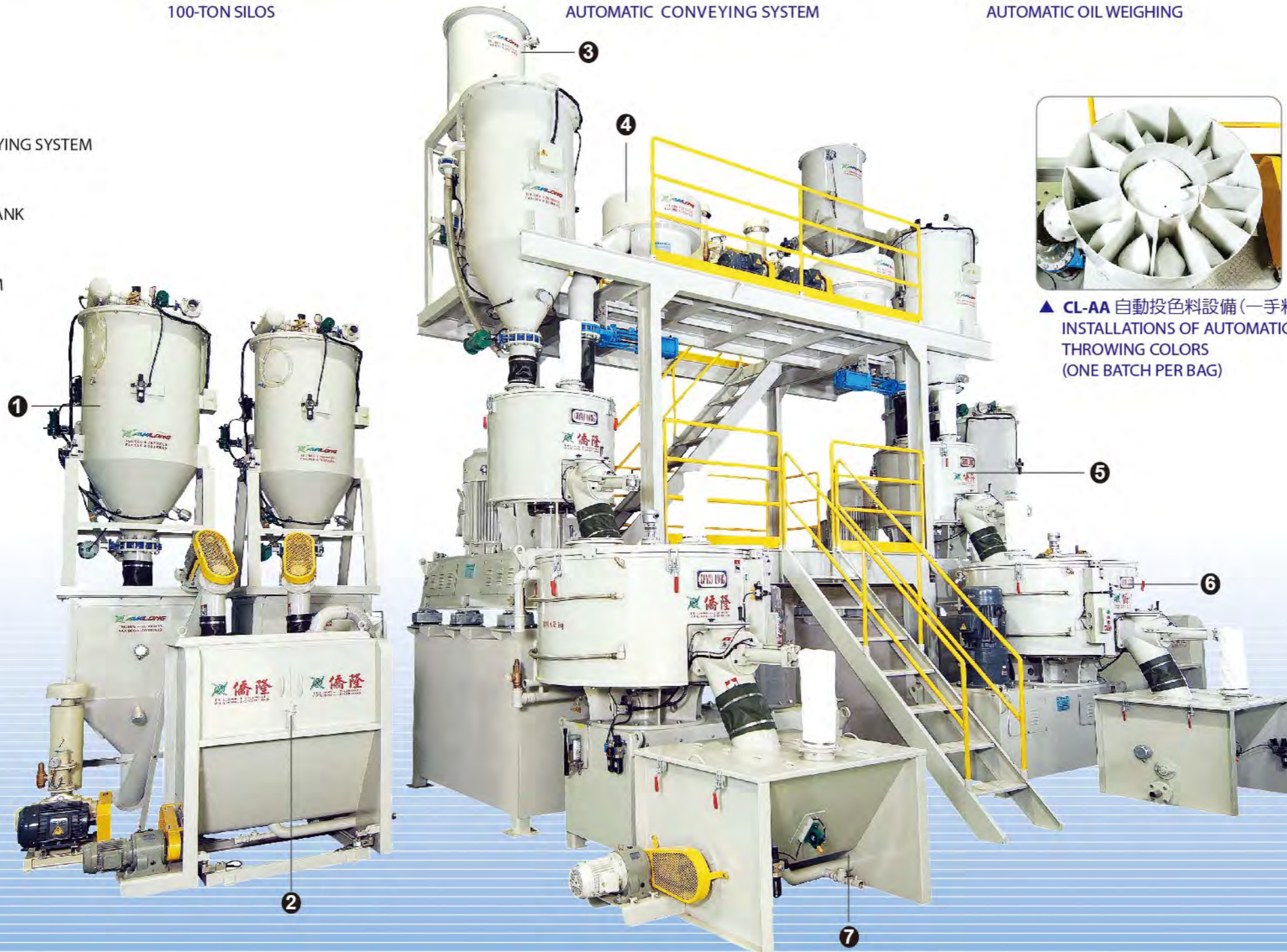

▲ CL-AA 自動投色料設備(一手料一包)
INSTALLATIONS OF AUTOMATIC
THROWING COLORS
(ONE BATCH PER BAG)



▲ 原料儲存桶
MATERIAL STORAGE TANK



▲ 自動輸送管線至押出機
AUTOMATIC CONVEYING SYSTEM
TO EXTRUDER

AUTOMATION

整廠規劃系統—粉液體全自動計量、高速混合、與管鍊輸送系統
 AUTOMATIC METERING, MIXING & CHAIN CONVEYING SYSTEM



太空包與小包粉體全自動計量
 AUTO METERING SYSTEM FOR BIG & SMALL BAGS POWDER

液體自動計量
 AUTO METERING SYSTEM FOR LIQUIDS

粉體大儲料槽
 SILOS FOR DRY BLEND POWDER

管鍊輸送系統至押出機
 CHAIN CONVEYOR SYSTEM TO EXTRUDERS



▲ 管鍊輸送
 CHAIN CONVEYOR



▲ 管鍊輸送
 CHAIN CONVEYOR



▲ 管鍊輸送
 CHAIN CONVEYOR



▲ PVC 管
 PVC PIPES



▲ PVC 門窗
 PVC WINDOW & DOOR
 PROFILES



▲ 門窗
 DOOR PROFILES



製造流程 PROCESS FLOW



▲ A. 粉體自動計量
 AUTO WEIGHING SYSTEM FOR POWDER



▲ B. 自動混合系統
 MIXING SYSTEM



▲ C. 螺旋輸送至大儲料桶
 SCREW CONVEYOR TO
 STORAGE SILO



▲ D. 管鍊輸送系統至押出機
 CHAIN CONVEYOR SYSTEM TO EXTRUDERS

AUTOMATION

整廠系列—混合自動計量輸送

FULLY AUTOMATIC MIXING、WEIGHING & CONVEYING SYSTEM

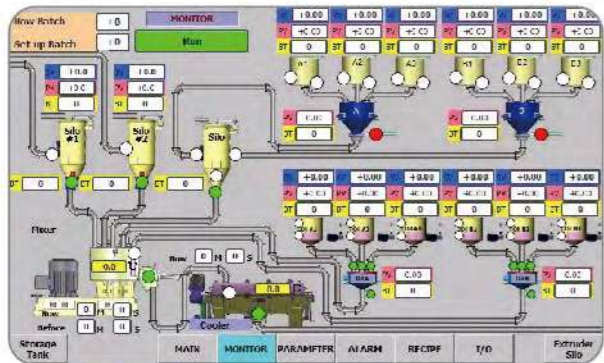

▲ 人機觸控螢幕介面 HMI TOUCH PANEL CONTROL SYSTEM

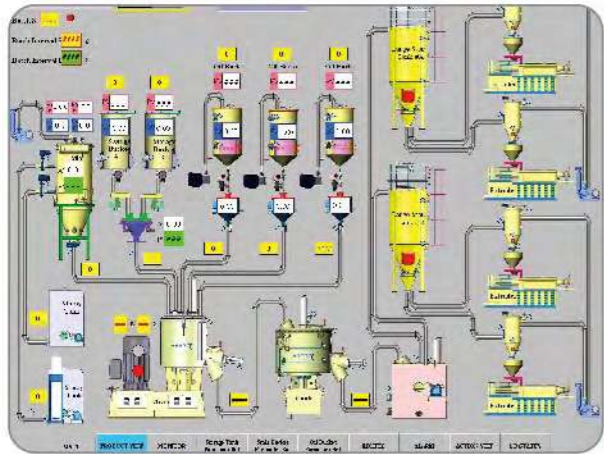

▲ PC電腦控制系統 PC CONTROL SYSTEM

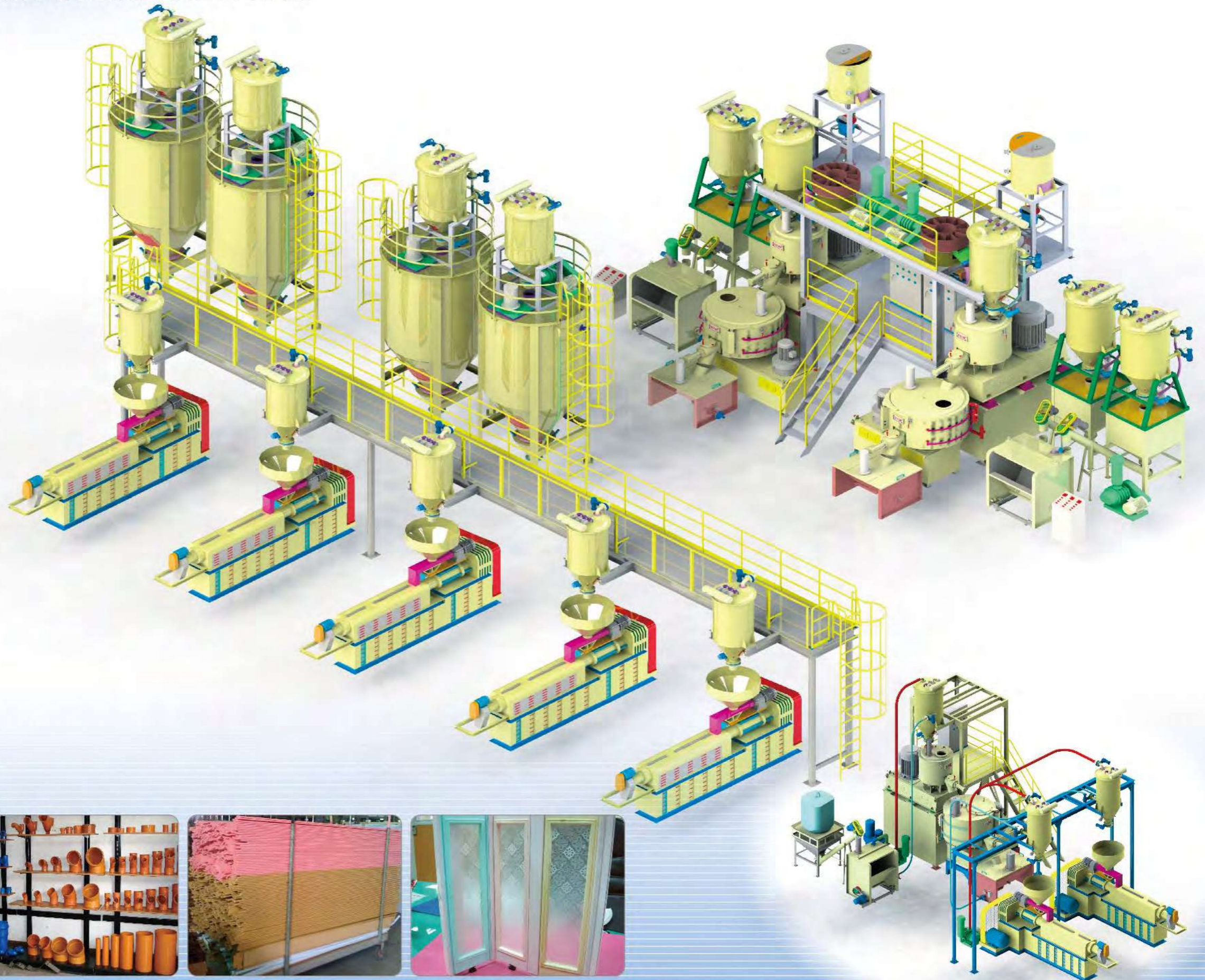

▲ 異型押出—拉門 PVC PROFILE



▲ PVC管&管件
PVC PIPE & FITTING



▲ PVC異型押出
PVC PROFILE



▲ PVC門窗異型押出
PVC WINDOW PROFILE

AUTOMATION

整廠系列-整廠自動化生產系統

FULLY AUTOMATED PRODUCTION SYSTEM

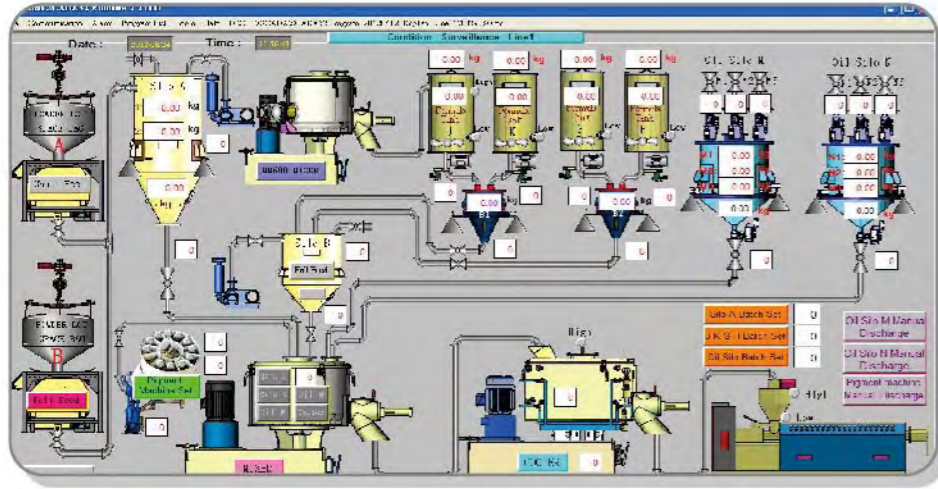

▲ PC電腦控制系統 PC CONTROL SYSTEM

中央電腦控制室
CENTRAL PC CONTROL ROOM

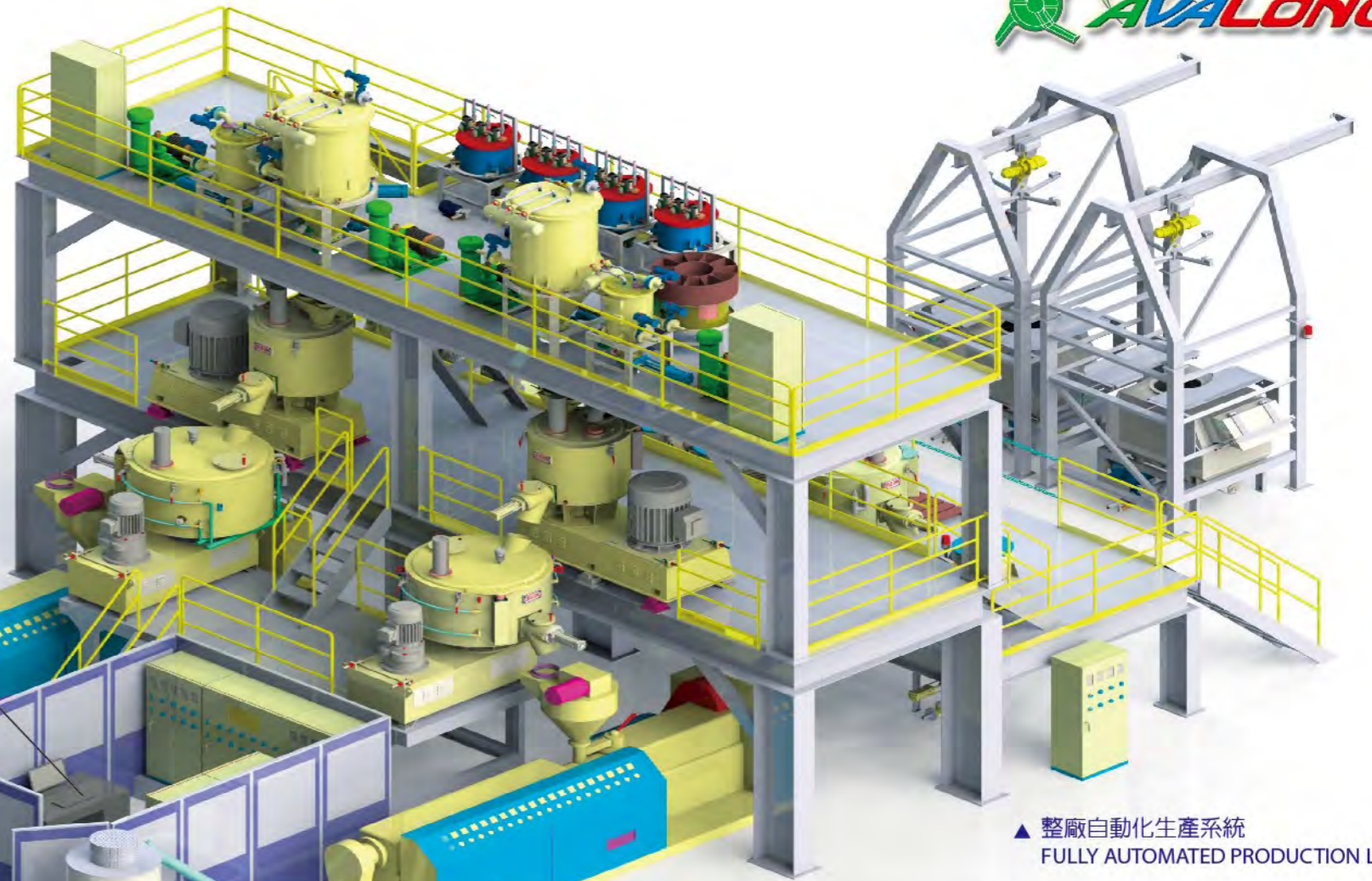

▲ 整廠自動化生產系統
FULLY AUTOMATED PRODUCTION LINE

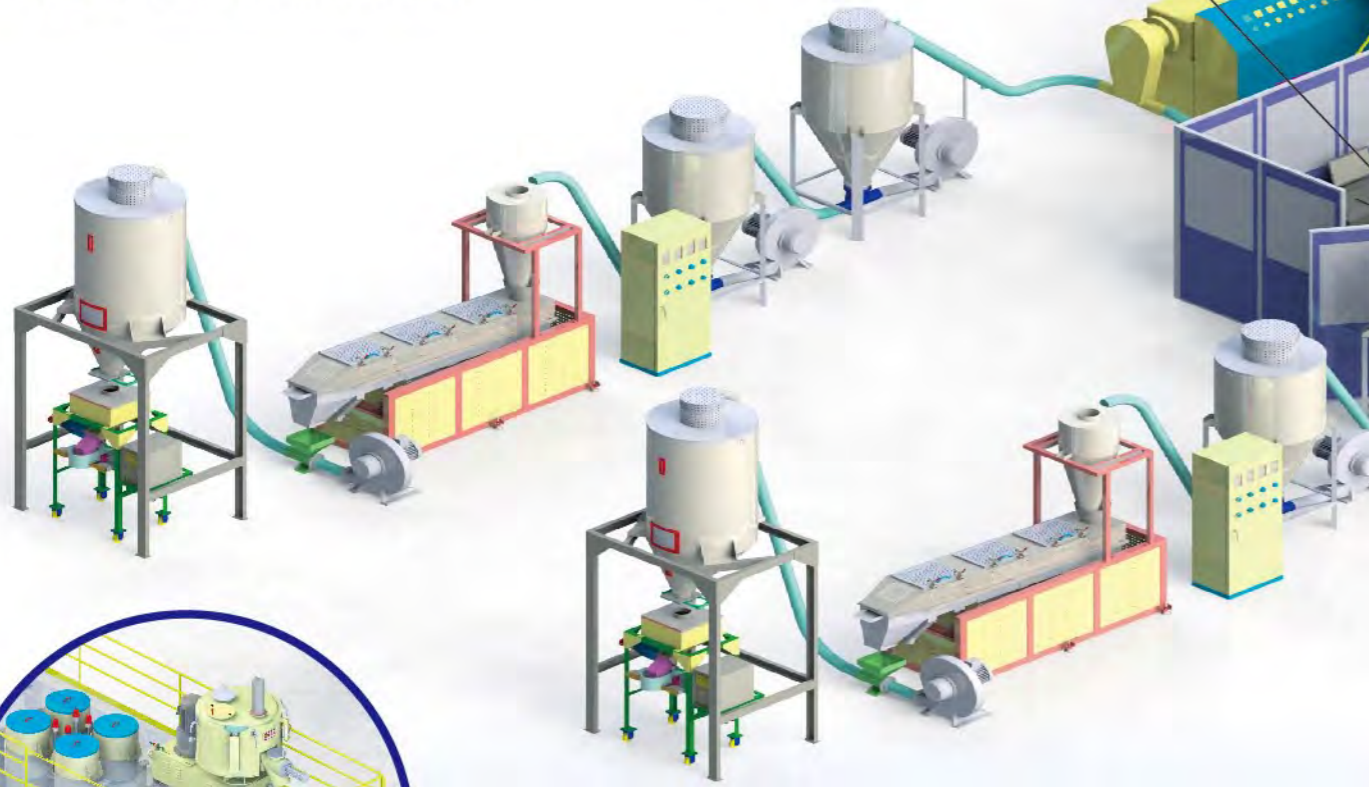

人工投料口
MATERIAL INLET
FOR SMALL BAG



天車
CRANE

1.0噸太空包
1 TON JUMBO BAG

入料口
INLET

鬆繩口
UNTYING HOLE

▲ 天車太空包
OVERHEAD CRANE JUMBO BAG UNIT

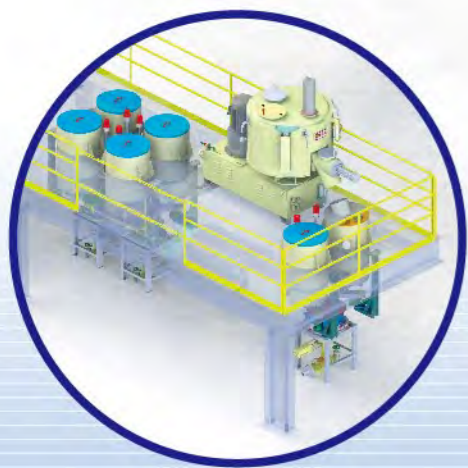

▲ 小量計量 (綜合安定劑、耐寒、耐熱、
抗氧化劑、DOP...等)
SMALL QUANTITY ADDITIVES WEIGHING
(PREMIXED STABILIZERS, ANTIOXIDANTS,
IMPACT MODIFIERS, ETC.)



▲ 小粉體計量
ADDITIVES WEIGHING SYSTEM



▲ 小粉體計量
ADDITIVES WEIGHING SYSTEM



PELLETIZING

整廠系列-雙螺桿式造粒整廠設備

TWIN SCREW PELLETIZING SYSTEM



▲ 電線電纜粒子(低煙無鹵)
CABLE & WIRE PELLETS
(LOW SMOKE & HALOGEN FREE)



▲ 鞋底/雨鞋粒子
PELLETS FOR SHOES
SOLE / BOOTS



▲ 仿木粒子
WPC PELLETS



▲ 籃球
PVC BALL



▲ 腳踏墊
CARPET



▲ 電線電纜線
CABLE & WIRE



▲ 鞋底/雨鞋
PVC SHOE SOLE / BOOTS



▲ 稻殼、椰子殼或咖啡殼+
廢料PE製成仿木材
WOOD PLASTIC COMPOUND
PROFILES MADE FROM RICE HULL,
COCONUT HUSK OR
COFFEE SHELL & RECYCLE PE.



▲ PVC 軟管
PVC HOSE



10

11

- 1 自動秤油系統 AUTOMATIC OIL SCALING SYSTEM
- 2 自動投色料設備
INSTALLATIONS OF AUTOMATIC THROWING COLORS
- 3 PVC自動秤料輸送系統(太空包)
PVC AUTOMATIC METERING CONVEYING SYSTEM
(JUMBO BAG)
- 4 高速混合機 HIGH SPEED MIXER
- 5 立式冷卻攪拌機 VERTICAL COOLING MIXER
- 6 PVC雙螺桿製粒押出機
TWIN SCREW PVC COMPOUNDING
PELLETIZER

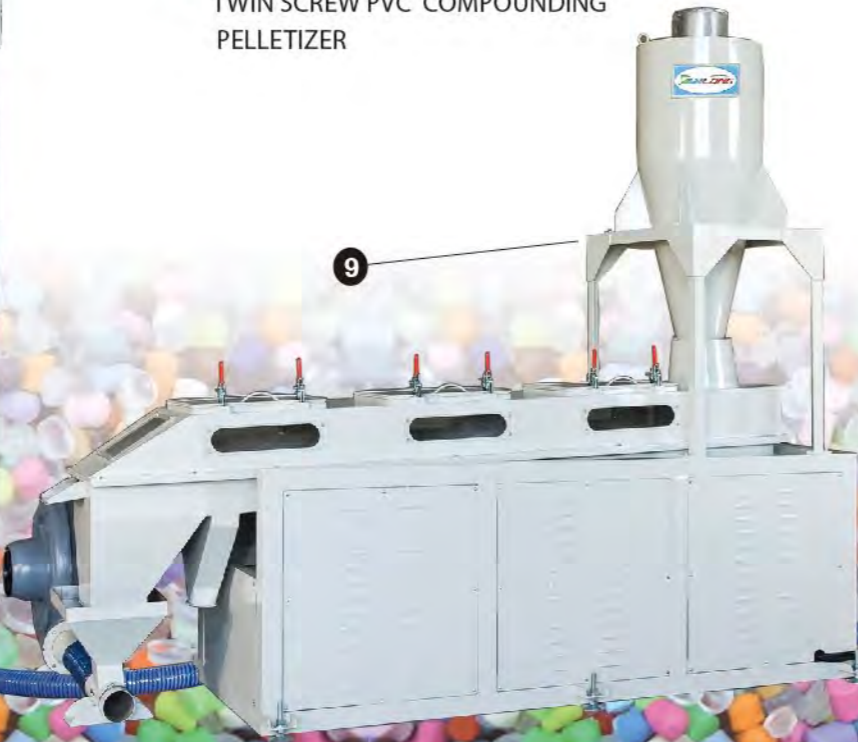

9



8

- 7 鼓風機 BLOWER
- 8 冷卻桶 COOLING BARREL
- 9 震動式冷卻機 VIBRATING COOLING UNIT
- 10 立式貯料桶 VERTICAL STORAGE BARREL
- 11 半自動秤料機
SEMI-AUTO
MATERIAL WEIGHING MACHINE

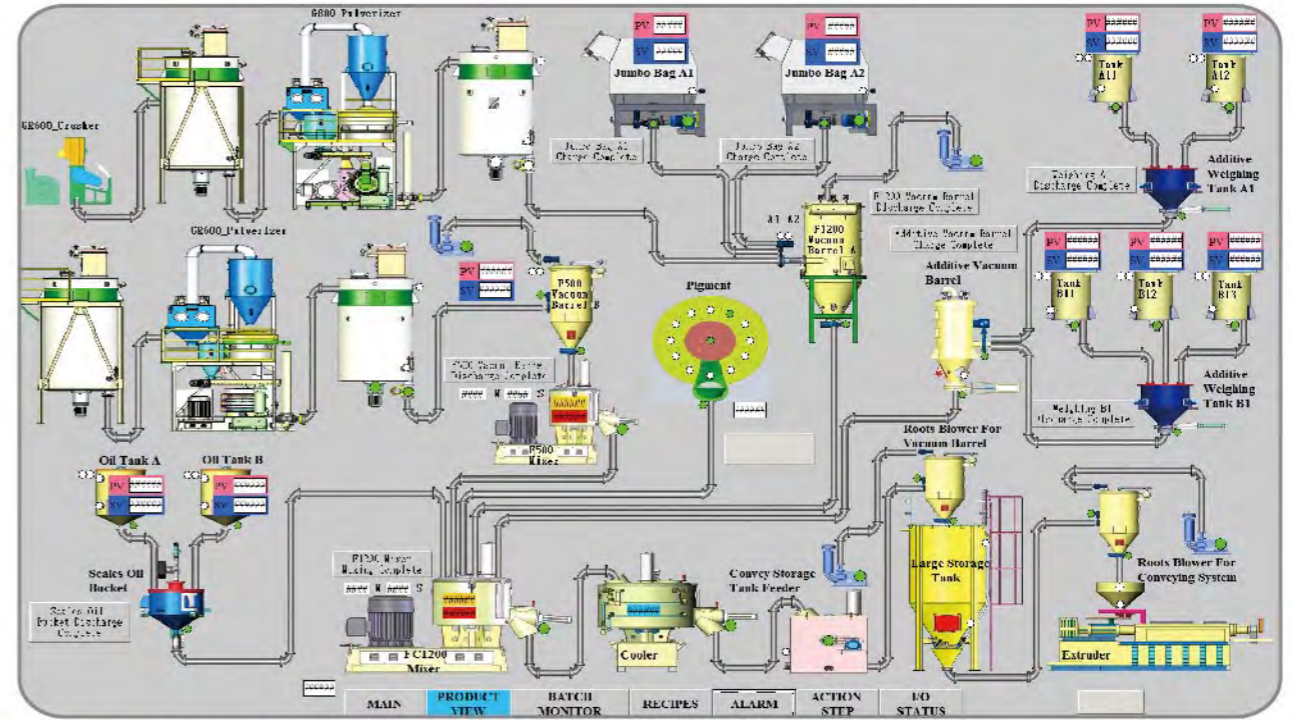

▲ PC電腦控制系統 PC CONTROL SYSTEM



4

5

6

7

7

PELLETIZING

造粒整廠設備

PVC COMPOUNDING SYSTEM



- 1 自動秤油系統 AUTOMATIC OIL SCALING SYSTEM
- 2 PVC自動秤料輸送系統(太空包)
PVC AUTOMATIC METERING CONVEYING SYSTEM (JUMBO BAG)
- 3 高速混合機 HIGH SPEED MIXER
- 4 臥式冷卻攪拌機
HORIZONTAL COOLING MIXER
- 5 PVC雙螺桿製粒押出機
TWIN SCREW PVC COMPOUNDING PELLETIZER
- 6 鼓風機 BLOWER
- 7 冷卻桶 COOLING BARREL
- 8 震動式冷卻機
VIBRATING COOLING UNIT
- 9 立式貯料桶
VERTICAL STORAGE BARREL



▲ 點滴管粒子
MEDICAL TUBES PELLETS



▲ 點滴管(醫療用)
MEDICAL TUBES



PELLETIZING

整廠系列-單螺桿式造粒

SINGLE SCREW PVC PELLETIZING SYSTEM



▲ 自動加油設備
AUTO OIL METERING UNIT

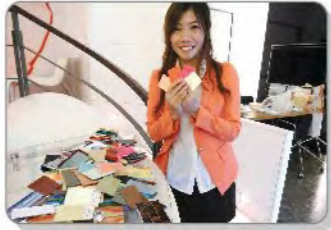

▲ 色母粒子
MASTERBATCH

- ① 振動式太空包組
OVERHEAD CRANE SET FOR JUMBO BAGS
- ② 圓型螺旋輸送機
ROUND BARREL TYPE SCREW CONVEYOR
- ③ 儲料中間桶
VACUUM BARREL
- ④ 高速混合機
HIGH SPEED MIXER
- ⑤ 立式冷卻攪拌機
VERTICAL COOLING MIXER
- ⑥ 自動秤油系統
AUTOMATIC OIL SCALING SYSTEM
- ⑦ 膠粒製造機
PELLETIZING MACHINE
- ⑧ 鼓風機 BLOWER



▲ 振動式輸送
VIBRATING FEEDER



▲ 雙螺桿小粉體計量
TWIN SCREW CONVEYOR

- ⑨ 單層振動篩
SINGLE-LAYER VIBRATING SIEVE
- ⑩ 鼓風機 BLOWER
- ⑪ 立式貯料桶
VERTICAL STORAGE BARREL

▼ 單螺桿式造粒
SINGLE SCREW PVC
COMPOUNDING SYSTEM



PELLETIZING

造粒整廠系列

PVC、EVA、PP/PE + CaCO₃、LSNH PVC+NBR、TPR COMPOUNDING SYSTEM



▲ 碳酸鈣粒子
FILLER PELLETS



▲ 低煙無毒(無鹵)
LOW SMOKE AND HALOGEN FREE

▲ 碳酸鈣粒子成品
FILLER COMPOUND PRODUCTS

▼ 自動秤料輸送系統
AUTOMATIC FEEDING & WEIGHING SYSTEM

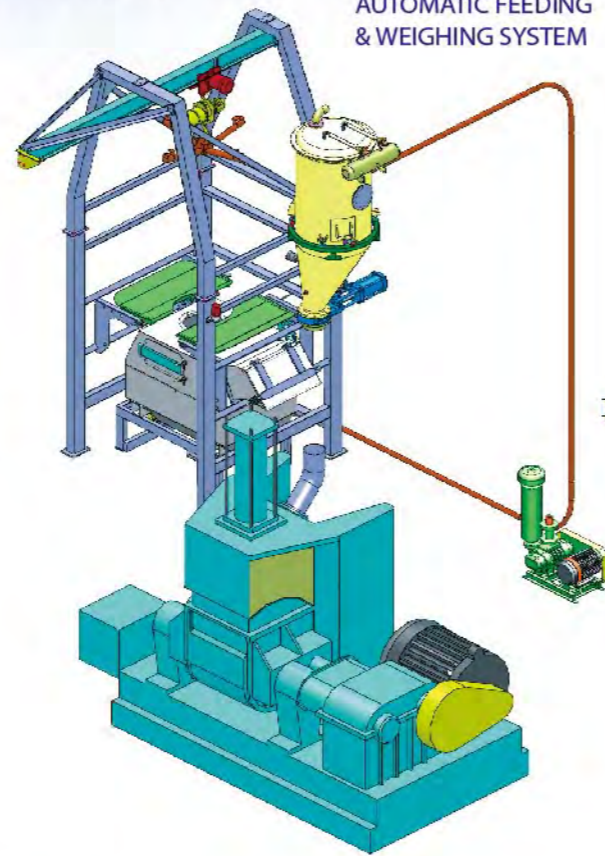

▼ 自動秤料輸送系統
AUTOMATIC FEEDING & WEIGHING SYSTEM

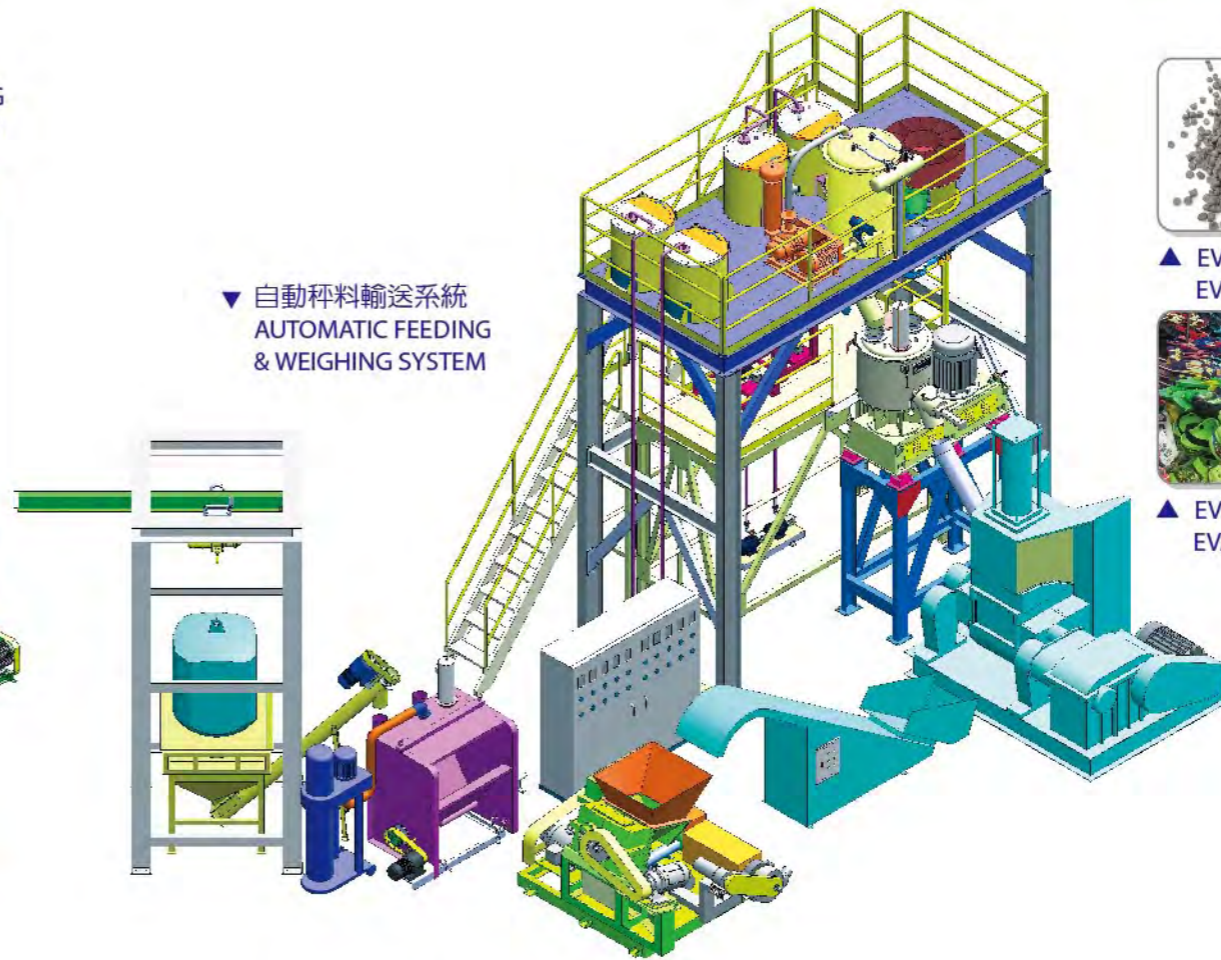

▲ EVA粒子
EVA PELLETS



▲ 橡膠粒子
PVC+NBR PELLETS



▲ EVA成品
EVA PRODUCT



▲ 橡膠封條
PVC+NBR SEAL



▲ 汽車橡膠封條
CAR RUBBER SEAL



- 1 密鍊捏合機 DISPERSION KNEADER
- 2 吊斗升降機 BUCKET CONVEYOR
- 3 膠粒製造機 PELLETISING MACHINE
- 4 鼓風機 BLOWER
- 5 冷卻桶 COOLING BARREL

- 6 鼓風機 BLOWER
- 7 單層振動篩 SINGLE-LAYER VIBRATING SIEVE
- 8 立式貯料桶 VERTICAL STORAGE BARREL
- 9 半自動秤料機 SEMI-AUTO MATERIAL WEIGHING MACHINE
- 10 裁縫機 BAG SEALING SYSTEM



WPC 製造流程
WPC PROCESS FLOW



▲ 天然回收木屑
NATURAL RECYCLED WOOD



▲ 精製木粉
WOOD POWDER



▲ 塑木粒子
WOOD PLASTIC COMPOSITE



▲ 塑木成品 WPC PRODUCTS



TPE PELLETIZING

整廠系列-TPE整廠設備輸出系統 水中造粒
 COMPLETE EQUIPMENT INSTALLATION
 FOR TPE

- 1 SBS
- 2 SEBS
- 3 OVERMOLDING (For PP, PE, PS, PMMA, PETg, ABS, PC, PA)
- 4 TPV
- 5 TPU (Hotmelt Adhesive)
- 6 TPEE

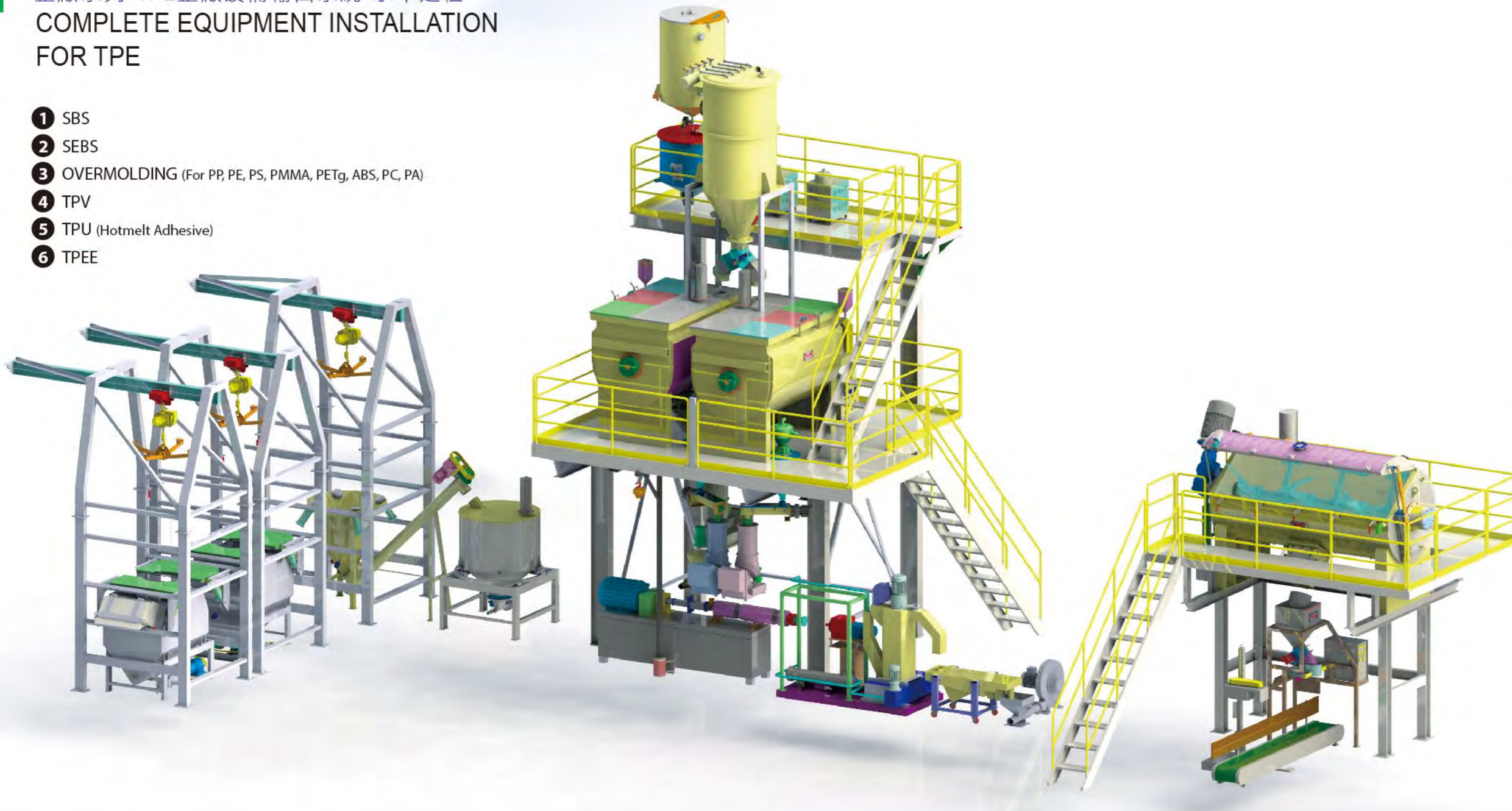

▲ TPE整廠設備
 COMPLETE EQUIPMENT FOR TPE



▲ TPE整廠設備
 COMPLETE EQUIPMENT FOR TPE



▲ TPE整廠設備
 COMPLETE EQUIPMENT FOR TPE



▲ TPE整廠設備
 COMPLETE EQUIPMENT FOR TPE



▲ TPE成品
 TPE PRODUCT



▲ TPE粒子
 TPE PELLETS

AUXILIARIES 附屬設備

特性

CL-V1: 震動篩濾冷卻機，適用於造粒混合之後的震動篩網選粒，以達到粒徑一致的品質，在篩選中逐漸以空氣漸冷以達到篩選冷卻目標。

FEATURES

CL-V1: Vibro-Screen Cooler, suitable for pellet selection via vibrating filter screen, to ensure that the quality and size of the pellets are consistent. During the screening process, cold air is used to lower the temperature, until reaching the screening and cooling standards.

▶ 震動式冷卻台
VIBRATING COOLING UNIT



規格 Specifications

型式 Model	作業能 Capacity	主機動力 Main Power	震動馬達 Vibrating Motor	機械尺寸 Machine Size	機械重量 Machine Weight
CL-V1-5Z	1000L	3 HP · 4P	1/2 HP · 4P	3300x1050x2550mm	800kg
CL-V1-10Z	1300L	5 HP · 4P	1 HP · 4P	3800x13500x2750mm	1100kg

- 1 CL-NA 半自動秤料機
SEMI-AUTO MATERIAL
WEIGHING MACHINE
- 2 CL-QVZR-DS 縫袋機
BAG SEALING SYSTEM

▶ 自動秤料加縫袋機
SEMI AUTOMATIC WEIGHING AND
BAG SEWING MACHINE



規格 Specifications

型式 Model	作業能 Capacity	主機動力 Main Power	機械尺寸 Machine Size	機械重量 Machine Weight
CL-QVZR-DS	400袋/Hr	1/2 HP · 4P	2250x1450x3000mm	800kg
CL-QVZR-DS1	600袋/Hr	1/2 HP · 4P	2250x900x1780mm	1200kg

本表僅供參考實際依顧客需求設計而定
This chart is only for reference. The actual design will be determined upon customers request.



SPECIAL 特殊客製化設計 CUSTOMISED DESIGN



◀ 油壓升降平台
ELEVATOR PLATFORM

高壓低速輸送系統

HIGH PRESSURE & LOW SPEED CONVEYING SYSTEM

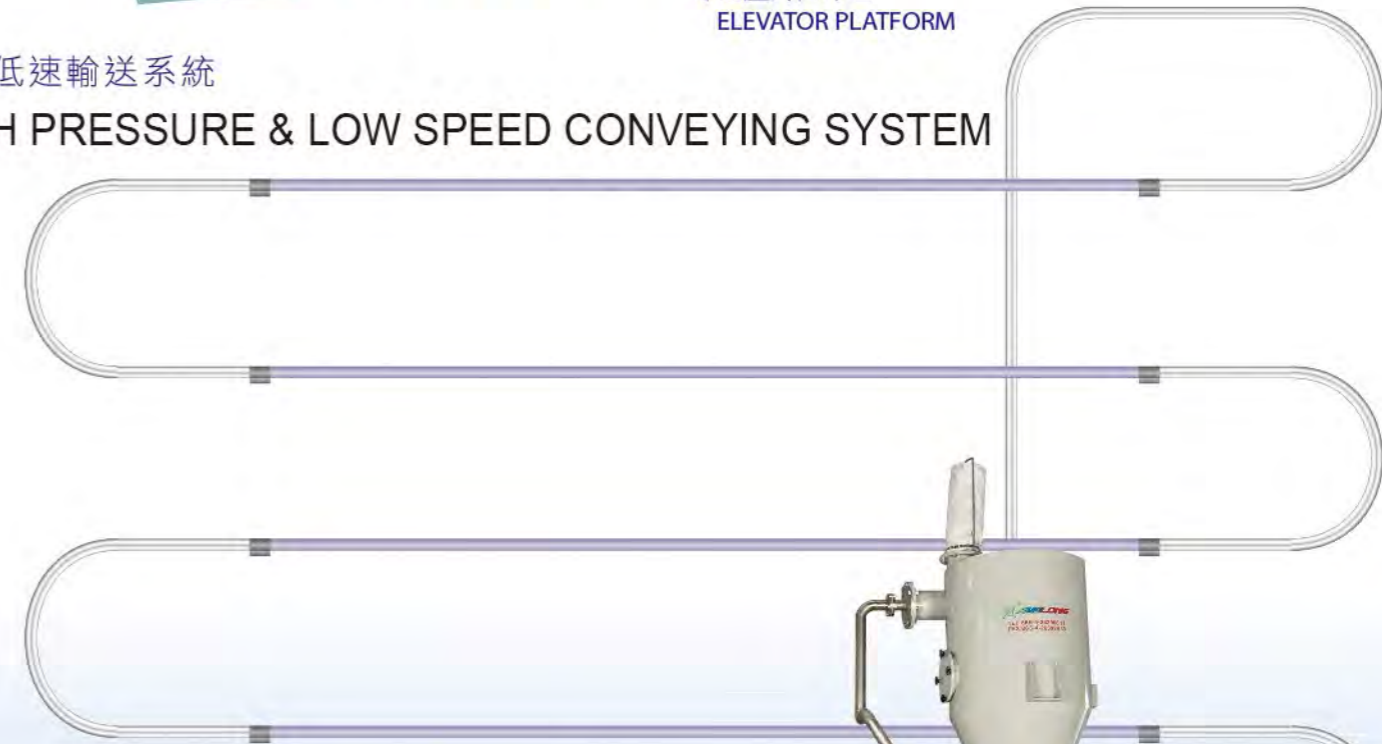

特性

適合各種塑膠、橡膠、穀物、礦物等粉粒體的自動輸送與自動倉儲；不受距離限制、粉粒體不會產生磨耗，防止粉塵污染既省人力有具環保概念產品。

FEATURES

Suitable for a variety of plastics, rubber, crops, and mineral power, automatic conveying and storage. This system has no distance limitations, no powder/resin loss in the conveying process, and it can also prevent dusting and save labor while adapting eco-friendly concepts.



PULVERIZER 磨粉機整套設備

G TYPE COMPLETE INSTALLATION OF PULVERIZER

特性

- 適用產品範圍: 高/低聚乙烯, 軟/硬質PVC, 聚丙烯, 聚苯乙烯, 聚醯胺, 聚合物, 含氮聚合物各式聚合物, 人造橡膠及其他。
- 磨粉尺寸: 從0.1mm至2mm性質極佳流暢之粉末。

FEATURES

- Suitable materials: HDPE, LDPE, flexible/rigid PVC, polypropylene, polystyrene, polyamide, polyester, copolymers, fluoropolymers and synthetic rubber etc.
- Pulverized Range: 0.1mm to 2mm quality powder for best flow with a specially developed disc mill.

自動填料機 (選購品)
AUTOMATIC VACUUM LOADERS (OPTIONAL)

冷凍機 (選購品)
WATER COOLER (OPTIONAL)



▲ 磁鐵棒
MAGNETIC RODS

震動篩選機 (選購品)
VIBRO SEPARATORS FILTER (OPTIONAL)



▲ 金屬檢測器 (選購品)
METAL SEPARATOR (OPTIONAL)



▲ 自動填料機 (選購品)
AUTOMATIC VACUUM LOADERS (OPTIONAL)



▲ CL-GK5 磨刀機 (選購品)
TOOL GRINDER (OPTIONAL)

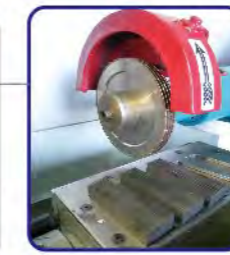

▲ 鑽石砂輪
DIAMOND GRIND STONE



▲ CL-GK1 磨刀機 (選購品)
TOOL GRINDER (OPTIONAL)



▲ 內部刀葉圖
INTERNAL MIXING BLADE



▲ 磨粉主機
THE MAIN UNIT OF PULVERIZER

規格 Specifications

型式 Model	主機動力 Main Power	機械尺寸 Machine Size	機械重量 Machine Weight
CL-G300	40HP	1650x900x1300mm	950kg
CL-G450	60HP	1800x1000x1450mm	1200kg
CL-G600	100HP	1950x1100x1550mm	1500kg
CL-G800	175HP	2150x1300x1800mm	1950kg

PULVERIZER

磨粉機系列—環保回收磨粉機整套設備

COMPLETE INSTALLATION OF PULVERIZER SERIES



特性

本機適用於多種回收料的粉碎如廢塑膠管、塑膠布、電腦基板、高爾夫球---等等。

FEATURES

This pulverizer is suitable for many materials; for example: plastic pipe, plastic cloth, computer boards, golf balls, etc.



▲ 資源回收料粉碎前/後
CRUSHED RECYCLED MATERIALS
BEFORE / AFTER



▲ 滾塑成品
ROTOUOLDING PRODUCTS



▲ PET回收廢料 PET RECYCLE MATERIAL

PULVERIZER

粉碎&磨粉機成套設備

CRUSHING, PULVERIZING ENTIRE WRAP FLOW EQUIPMENT



特性

- 適用產品範圍: 高/低聚乙烯, 軟/硬質 PVC, 聚丙烯, 聚苯乙烯, 聚醯胺, 聚合物, 含氮聚合物各式聚合物, 人造橡膠及其他。
- 磨粉尺寸: 從0.1mm至2mm性質極佳流暢之粉末。

FEATURES

- Suitable materials: HDPE, LDPE, flexible/rigid PVC, PP, PS, PA, PET, Copolymer (ABS, SBR, SIS), Fluoropolymers, Synthetic Rubber, etc.
- Pulverized Range: 0.1mm to 2mm quality powder for best flow with a specially designed disc mill.



▲ PVC+木粉料從粉碎到磨粉一貫作業流程
PROCESSING OF PVC & WOOD FROM CRUSHING TO PULVERIZING

成品儲料桶
STORAGE TANK FOR FINAL PRODUCTS

袋濾桶
BAG FILTER TANK

立式儲料桶
VERTICAL STORAGE BARREL

粉碎機
CRUSHER

鼓風機
BLOWER

活動式卸料台車
MATERIAL LOADER

彈簧螺旋輸送機
SPRING-TYPE SCREW CONVEYOR

冷凍機
WATER COOLER

磨粉主機
THE MAIN UNIT OF PULVERIZER

▼ 木材
WOODEN SAWDUST



▲ 粉碎後 CRUSHED



▲ 磨粉後 PULVERIZER

SPECIAL 特殊機型-磨粉機整套

SPECIAL DESIGN OF PULVERIZER SERIES

特性

- 適用產品範圍:高/低聚乙烯, 軟/硬質 PVC, 聚丙烯, 聚苯乙烯, 聚醯胺, 聚合物, 含氮聚合物各式聚合物, 人造橡膠及其他。
- 磨粉尺寸: 從0.1mm至2mm性質極佳流暢之粉末。

FEATURES

- Suitable materials: HDPE, LDPE, flexible/rigid PVC, polypropylene, polystyrene, polyamide, polyester, copolymers, fluoropolymers and synthetic rubber etc.
- Pulverized Range: 0.1mm to 2mm quality powder for best flow with a specially designed disc mill.

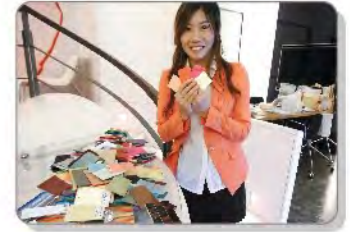

▲ 色母粒子
MASTERBATCH



SPECIAL

特殊機型—磨粉機成套

COMPLETE SET OF PULVERIZER

特性

此型磨粉機的填料，由自動給料機吸料供應，可節省人力。成品經旋風桶卸料與集塵。

FEATURES

The material feeding of this model of pulverizer is provided by an automatic material loader, thus reducing manpower. The powder is conveyed through the cyclone separator for material discharge and dust collecting.



特性

綜合安定劑反應爐，從粉體反應成液體，再從液體反應成粉體，然後經由磨粉機磨至極細粉末。

FEATURES

Stabilizer reactor for reacting powder to liquid and liquid to powder, after which, is pulverized to fine powder.



PULVERIZER

旋轉式磨粉機整套設備

GR TYPE COMPLETE INSTALLATION OF ROTATING PULVERIZER

特性

本機適用多種原料如壓克力、PU鞋底、ABS塑膠、木材、穀類、礦物、陶土可磨，壽命非常短....磨成粉狀。

FEATURES

This machine is suitable for pulverizing various materials such as acrylic, PU shoe soles, ABS plastics, wood, grains, minerals, clay, powder metallurgy, etc., into powder.



▲ 高爾夫球
GOLF BALLS



▲ 粉碎後 CRUSHED



▲ 磨粉後 PULVERIZED



▲ 磨粉前 BEFORE



▲ 磨粉後 AFTER



▲ 內部刀葉圖
INTERNAL MIXING BLADES



冷凍機 (選購品)
WATER COOLER
(OPTIONAL)



▲ 磨粉主機
PULVERIZER MAIN UNIT

規格 Specifications

型式 Model	主機動力 Main Power	機械尺寸 Machine Size	機械重量 Machine Weight
CL-GR450	60HP	1800x1000x1450mm	1200kg
CL-GR600	100HP	1950x1100x1550mm	1500kg
CL-GR800	150HP	2150x1300x1800mm	1950kg

PULVERIZER 錘擺式磨粉機

GJ TYPE HAMMERING PULVERIZER



▲ 磨粉主機
THE MAIN UNIT OF PULVERIZER

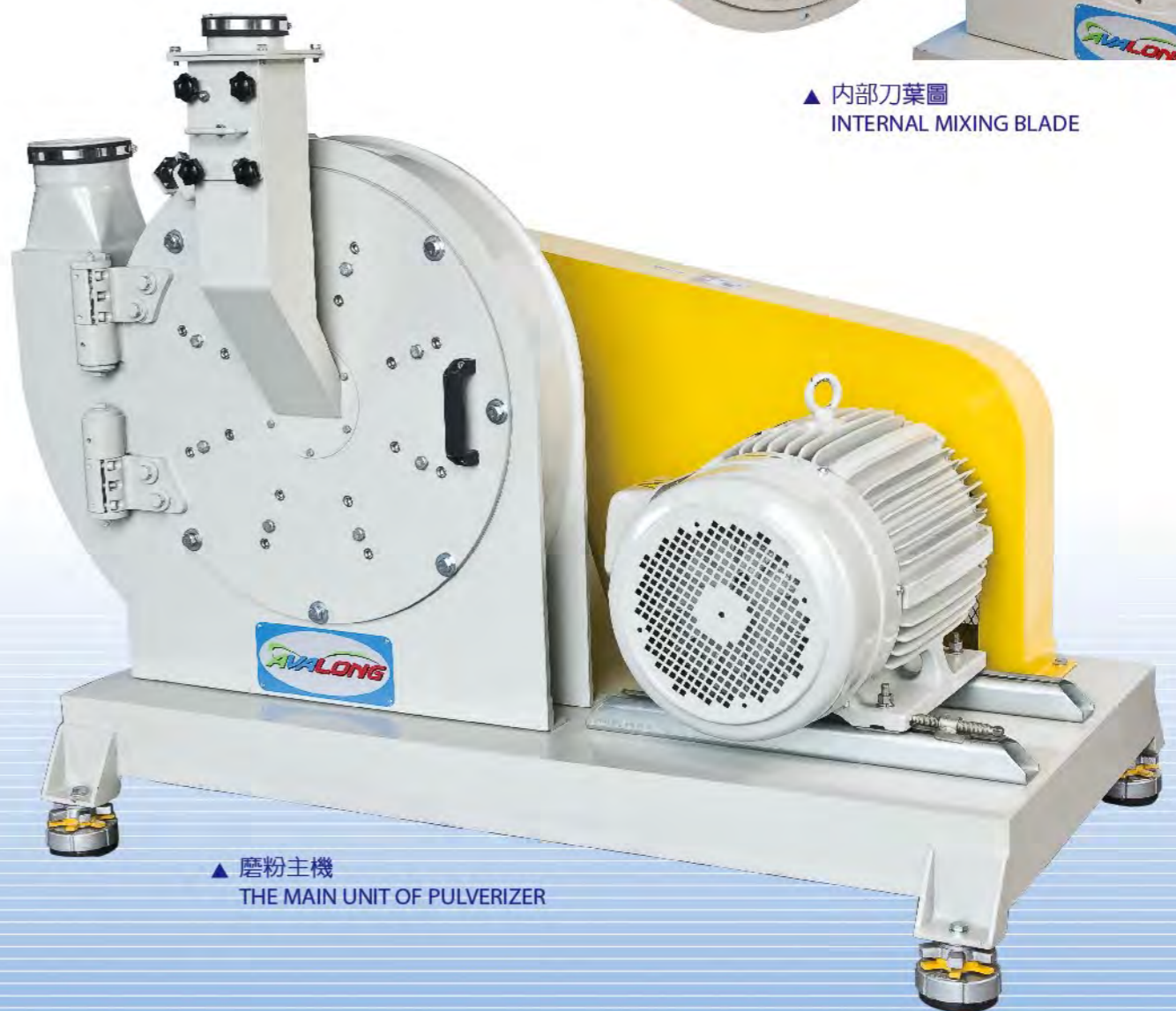

▲ 磨粉主機
THE MAIN UNIT OF PULVERIZER



▲ 內部刀葉圖
INTERNAL MIXING BLADE



▲ 石英 QUARTZ



▲ 粉碎後 CRUSHED



▲ 牡蠣殼 OYSTER SHELL



▲ 磨粉後 PULVERIZED



▲ 磨粉後 PULVERIZED



▲ 黃豆 SOY BEANS



▲ 磨粉後 PULVERIZED

特性

本機適用多種原料磨粉作業，如假性結塊、玻璃纖維、陶瓷、陶土、熟石灰、ABS樹脂、矽膠樹脂、碳纖維、活性炭、細糖、大豆粉、米麥殼類、煅燒牡蠣殼等等的磨成粉狀。

FEATURES

This machine is suitable for various types of material pulverizing, including false lumps, fiberglass, ceramics figuline, calcium hydroxide, ABS resins, silicon resins, carbon fiber, activated carbon, fine sugar, soybean powder, rice & grain hulls, calcined oyster shell, etc.

規格 Specifications

型式 Model	主機動力 Main Power	機械尺寸 Machine Size	機械重量 Machine Weight
CL-GJ450	30HP	13500x850x1045mm	1000kg
CL-GJ600	40HP	1585x910x12000mm	1200kg

AGGLOMERATOR 搓粒機系列



COMPLETE INSTALLATION OF AGGLOMERATOR MACHINE SERIES

特性
此型搓粒機是僑隆公司配合客戶的需求，所研發設計出高效率高品質之產品，此產品之完美性能及外觀可符合每位使用者之各種使用目的，可被用於廣泛產品範圍，如易飛揚粉狀體，高分子化學工業，生化科技，合成樹脂，陶瓷產品，粉末冶金等，以上產品經特殊搓粒盤摩擦加熱反應，或以噴霧結合液，混合成0.5mm至20mm圓球型粒子。希望此產品能為您創造出更高附加價值之添加產品，並保證所有原料品質的提升，來滿足客戶需求。

FEATURES

This agglomerator is made by Chyau Long to meet various user needs. the advantages of excellent efficiency and quality, perfect working performance and resemblance; they can also be used for a wide range of raw materials, such as easy-flow powder, high-molecular chemical industry, bio-technology, synthetic resin, ceramic products, and powder metallurgy etc. The above mentioned raw materials are processed by specially designed granulating disc through friction heat or by spray binder liquid to compound them into 0.5~20mm round pellets. Our machines not only increase your profit, but also improve the quality of your products.



▲ 圓球型粒子
ROUND PELLETS



特性
此機型搓粒機是針對廢料回收，再生利用，如塑膠袋類等回收物將之搓成粒子。

FEATURES

This agglomerator is specially designed for recycled materials regeneration, for materials such as plastic bags recycled materials etc.



▲ 塑膠袋
PLASTIC BAGS



▲ 塑膠袋粒子
PLASTIC BAGS PELLETS



▲ PET 織布
PET FABRIC



▲ PET 織布粒子
PET FABRIC PELLETS

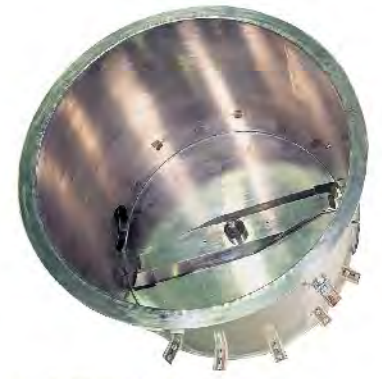

▲ 內部刀葉圖
INTERNAL MIXING BLADE

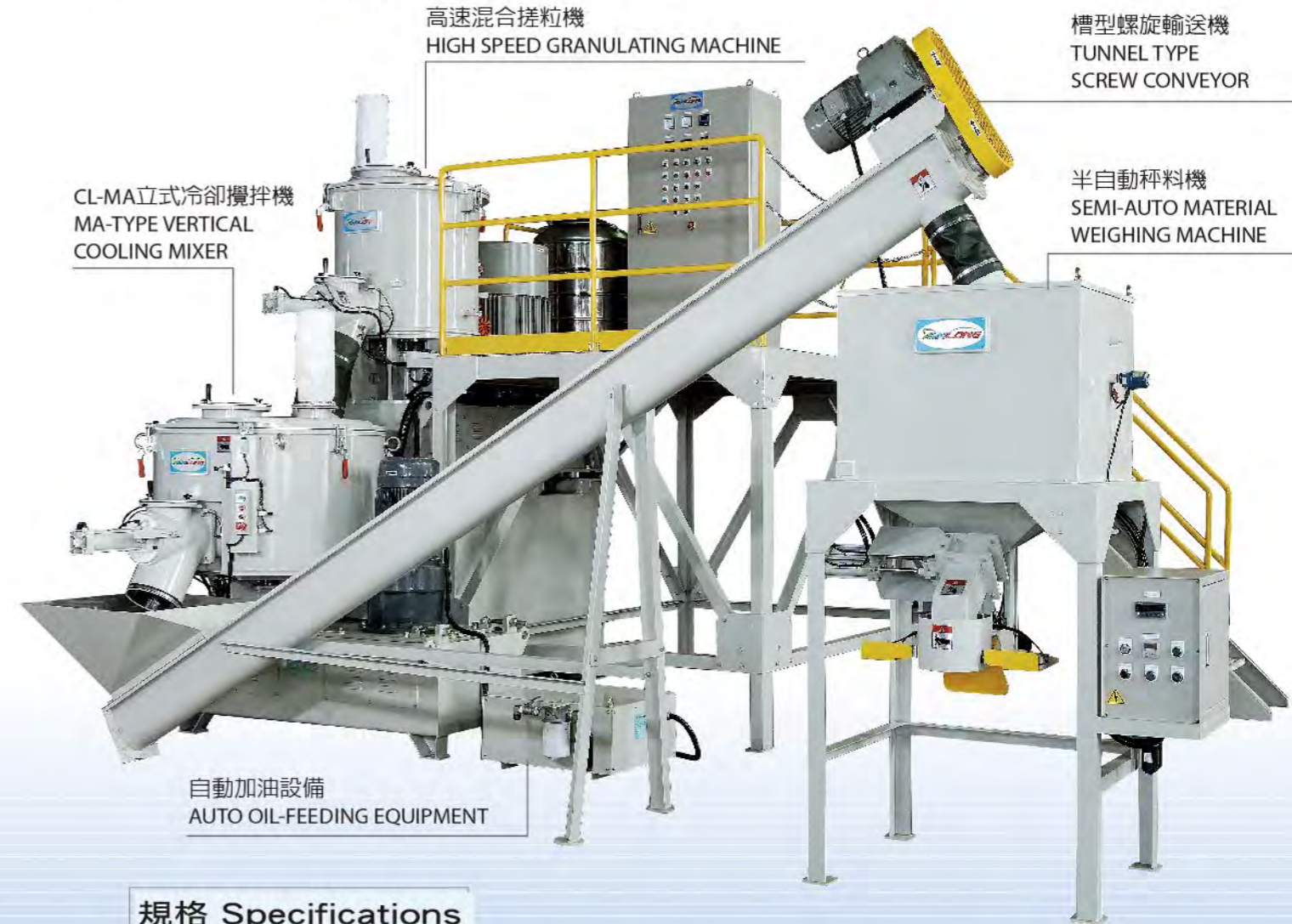

CL-MA立式冷卻攪拌機
MA-TYPE VERTICAL COOLING MIXER

高速混合搓粒機
HIGH SPEED GRANULATING MACHINE

槽型螺旋輸送機
TUNNEL TYPE SCREW CONVEYOR

半自動秤料機
SEMI-AUTO MATERIAL WEIGHING MACHINE

自動加油設備
AUTO OIL-FEEDING EQUIPMENT

規格 Specifications

規格 Specifications

型式 Model	物料入量 Feeding Capacity	動力 Power	機械尺寸 Machine Size	機械重量 Machine Weight
CL-MP200	70-140L	10HP · 4P	1700x900x1500mm	1000kg
CL-MP400	150-300L	15HP · 4P	1850x1050x1600mm	1200kg
CL-MP600	200-400L	20HP · 4P	2050x1300x1750mm	1500kg

型式 Model	全容量 Tank Capacity	主機動力 Main Power	機械尺寸 Machine Size	機械重量 Machine Weight
CL-F100-PE	130L	20HP · 4P	1800x750x1600mm	1300kg
CL-F200-PE	250L	60HP · 4P	2300x900x1900mm	1800kg
CL-F400-PE	420L	75HP · 4P	2800x1200x2300mm	3400kg
CL-F600-PE	650L	100HP · 4P	2800x1120x2300mm	3600kg
CL-F1300-PE	1300L	125HP · 4P	3760x1600x2300mm	5600kg

SAMPLE 搓粒樣品圖示

SAMPLES OF GRANULATED MAIERIALS

搓粒前 BEFORE GRANULATING	搓粒後 AFTER GRANULATING	搓粒前 BEFORE GRANULATING	搓粒後 AFTER GRANULATING
			
▲ PE袋 PE BAGS	▲ PE袋 PE BAGS	▲ 垃圾袋 PLASTIC BAGS	▲ 垃圾袋 PLASTIC BAGS
			
▲ 氣泡布 AIR BUBBLE SHEET	▲ 氣泡布 AIR BUBBLE SHEET	▲ 氣泡布 AIR BUBBLE SHEET	▲ 氣泡布 AIR BUBBLE SHEET
			
▲ 尿布 DIAPERS	▲ 尿布 DIAPERS	▲ 打包帶 STRAPPING TAPE	▲ 打包帶 STRAPPING TAPE
			
▲ HDPE	▲ HDPE	▲ 壁紙 WALL PAPER	▲ 壁紙 WALL PAPER
			
▲ PET織布 PET FABRIC	▲ PET織布 PET FABRIC	▲ 桌巾 CLOTH	▲ 桌巾 CLOTH

SAMPLE 磨粉樣品圖示

SAMPLES OF PULVERIZED MAIERIALS

磨粉前 BEFORE	磨粉後 AFTER	磨粉前 BEFORE	磨粉後 AFTER
			
▲ PVC硬質膠布 RIGID PVC SHEET	▲ PVC硬質膠布 RIGID PVC SHEET	▲ PVC管 PVC PIPE	▲ PVC管 PVC PIPE
			
▲ POM	▲ POM	▲ PP	▲ PP
			
▲ PVC	▲ PVC	▲ PVC SHEET	▲ PVC SHEET
			
▲ PET	▲ PET	▲ LLDPE	▲ LLDPE
			
▲ LDPE	▲ LDPE	▲ HDPE	▲ HDPE
			
▲ EVA	▲ EVA	▲ IC管 IC PIPE	▲ IC管 IC PIPE

SAMPLE 磨粉樣品圖示

SAMPLES OF PULVERIZED MAIERIALS



磨粉前 BEFORE	磨粉後 AFTER	磨粉前 BEFORE	磨粉後 AFTER
▲ 栗子 CHESTNUT	▲ 栗子 CHESTNUT	▲ 花生 PEANUT	▲ 花生 PEANUT
▲ 竹子 BAMBOO	▲ 竹子 BAMBOO	▲ 木屑 SAW DUST	▲ 木屑 SAW DUST
▲ 高爾夫球 GOLF BALL	▲ 高爾夫球 GOLF BALL	▲ 米殼 RICE HUSK	▲ 米殼 RICE HUSK
▲ 紅高粱 SORGHUM	▲ 紅高粱 SORGHUM	▲ 米糠 RICE HUSK PRODUCT	▲ 米糠 RICE HUSK PRODUCT
▲ 橡膠 RUBBER TYRE	▲ 橡膠 RUBBER TYRE	▲ 運動鞋底 EVA,TPR SHOE SOLE	▲ 運動鞋底 EVA,TPR SHOE SOLE
▲ 茶葉 TEA	▲ 茶葉 TEA	▲ 竹炭 CHARCOAL	▲ 竹炭 CHARCOAL

EXHIBITIONS WORLD WIDE 世界各國展覽實況



▲ 2016 沙烏地展 SAUDI-PPP



▲ 2016 俄羅斯展 INTERPLASTICA MOSCOW-RUSSIA



▲ 2016 伊朗展 IRAN PLAST



▲ 2016 德國展 K-SHOW, GERMANY



▲ 2017 杜拜展 ARABPLAST- DUBAI



▲ 2017 巴西展 FEIPLASTIC -BRASIL



▲ 2017 廣州展 CHINAPLAS -GUANGZHOU



▲ 2017 墨西哥展 PLASTIMAGEN-MEXICO

本公司部份銷售實績
OUR SALES REFERENCE

公司 / COMPANY	銷售地區 / LOCATION
MILBRIDGE HOLDING SA	ANGOLA
AUSTRALIAN PLASTIC PROFILES PTY.LTD	AUSTRALIA
A.P.N COMPOUNDING PTY.LTD	AUSTRALIA
CAHAN INDUSTRIAL COMPLEX	AZERBAIJAN
PROSTAR GROUP	BANGLADESH
WALTON HI-TECH INDUSTRIES LTD.	BANGLADESH
ASPERBRAS TUBOS E CONEXOES LTDA	BRAZIL
BBC INDUSTRIA E COMERCIO LTDA.	BRAZIL
BIANCHINI INDUSTRIA DE PLASTICOS LTDA (PLASBIL)	BRAZIL
FORTLEV INDUSTRIA E COMERCIO DE PLASTICOS LTDA (BA PLANT)	BRAZIL
INFIBRA S/A	BRAZIL
POLYFIT INDUSTRIA E COMERCIO LTDA	BRAZIL
PILAPLAST INDUSTRIA E COMERCIO DE PLASTICOS LTDA.	BRAZIL
PERFILYNE INDUSTRIA E COMERCIO DE PERFIS PLASTICOS LTDA	BRAZIL
LANAPLAST INDUSTRIA DA AMAZONIA LTDA	BRAZIL
UNIPLAST SA	BRAZIL
ATC INDUSTRY LTD	CENTRAL AFRICA
GE PLASTICS CO., LTD	CHINA.
CHINA NATIONAL BLUESTAR GROUP (中國藍星集團)	CHINA
SABIC INNOVATIVE PLASTICS	CHINA
FOXCONN TECHNOLOGY GROUP (鴻海集團)	CHINA
PETROFLEX S.A.	CHILE
ROTOPLASTIC	CHILE
ARKIPLAST S.A / CIELOPLAST INTERNATIONAL S.A.	COSTA RICA
PLASTICAUCHO INDUSTRIAL S.A.	ECUADOR
PLASTICOS RIVAL CIA. LTDA.	ECUADOR
AMANCO PLASTIGAMA S.A.	ECUADOR
SHAWWA PLASTIC	EGYPT
PLASTIC PRODUCTS MANUFACTURING / TILAHUN GEBREMICHAEL GEBRETSADKAN	ETHIOPIA
YT PLASTIC PRODUCTION	ETHIOPIA
DOMINION CABLES	FIJI
TECE GMBH	GERMANY
RESYSTA ASIA PTE LTD	GERMANY/CHINA
OOO "POLYMER-CHEMIE RUS"	GERMANY/RUSSIA
REHAU PTE LTD (GERMANY德國)	GERMANY,INDIA.CHINA
BRIGHT COLORS	GREECE
TOPAZ MULTI-INDUSTRIES SARL	GUINEA
GAFSONS GROUP OF COMPANIES(GAFOOR)	GUYANA
PT. AVIA AVIAN	INDONESIA
PT. ANEKA KABEL ELEKTRIK	INDONESIA
PT.ATEJA TRITUNGGAL	INDONESIA
PT.CHING LUH INDONESIA 印尼清祿化工部	INDONESIA
PT.MARGACIPTA WIRASENTOSA	INDONESIA
PT. POU CHEN INDONESIA 寶成工業股份有限公司(印尼)	INDONESIA
PT. LAUTAN LUAS TBK	INDONESIA
FINOLEX CABLES LTD.	INDIA
MOTHERSON SUMI ELECTRIC WIRE	INDIA
PART LASTIC GROUP	IRAN
SANAYE VARAQ IRAN S.A	IRAN
AL HELAL FOR FOAM MANUFACTURING	IRAQ
MDC PLASTIC INDUSTRIES LTD	ISRAEL
ASAHI ORGANIC CHEMICALS INDUSTRY CO.	JAPAN
TIEJIN CHEMICALS 帝人化學	JAPAN
IRIS OHYAMA INC 愛麗忠歐雅瑪	JAPAN
HITACHI CABLE 日立電線株式會社	JAPAN
SHOWA CHEMICALS 昭和化成	JAPAN
MITSUBISHI CHEMICAL CORPORATION 三菱化學	JAPAN
TOYO INK MFG.CO.,LTD. 東洋油墨	JAPAN
DAINICHISEIKA COLOR & CHEM MFG CO., LTD. 大日精化工業株式會社	JAPAN
SEKISUI CHEMICAL CO., LTD 積水塑膠管材股份有限公司	JAPAN
TOMATEC (TOKAN MATERIAL TECHNOLOGY) 東罐材料技術株式會社	JAPAN
INOAC CORPORATION	JAPAN
ORIENT PLASTIC CO. / FORMOSA PLASTIC INDUSTRIES	JORDAN
PETRA CABLES & ELECTRICAL WIRES MANUFACTURING CO.	JORDAN
AL AYED GROUP INDUSTRIAL GROUP / AL AYED HOSES FACTORY	K.S.A.
KAZAKHSTAN PETROCHEMICAL COMPANY CHEMICAL (KPCC)	KAZAKHSTAN
STATUS PLAST LLP	KAZAKHSTAN
PLASTIC COMPOUNDING (EPZ) LTD	KENYA
SAMBU FINE CHEMICAL CO.,LTD.	KOREA



本公司部份銷售實績
OUR SALES REFERENCE

公司 / COMPANY	銷售地區 / LOCATION
KOCH CO., LTD	KOREA
AL-NAWRAS PLASTIC BAG CO.W.L.L.	KUWAIT
SHERA AL KHALEEJ FACTORY CO. FOR FIBERGLASS & POLYETHYLENE	KUWAIT
BRILLIANT SUCCESS SDN.BHD. 美聯工業有限公司	MALAYSIA
CHIANTA PLASTIC INDUSTRIES SDN.BHD	MALAYSIA
INDOCHINE BIO PLASTIQUES (ICBP) SDN BHD	MALAYSIA
SUNACE KAKOH (PTE) LTD	MALAYSIA.SINGAPORE.JAPAN
PPP PIPING SYSTEMS LTD.	MAURITIUS
PVC GLOBAL, S.A. DE C.V.	MEXICO
VITROMAGIC SA DE CV	MEXICO
LAS MEJORES SANDALIAS SV DE CV	MEXICO
PLASTICOS HELER DE MEXICO S.A. DE C.V.	MEXICO
ACRILICOS SABLON, S.A. de C.V.	MEXICO
RECOZA	MEXICO
INDUPLASTIC DE MEXICO SA DE CV	MEXICO
BATI PLAST SARL	MOROCCO
ETUI PLAST	MOROCCO
TUMAG CABLES	MOROCCO
PLASTIMA S.A.	MOROCCO
WIN THAN HTAY MIN CO.,LTD / PO-SENG UPVC PIPE & FITTING FACTORY	MYANMAR
BENHUR TRADING CO.,LTD.	MYANMAR
NATIONAL PLASTIC FACTORY	OMAN
MUSCAT LEADING PLASTIC COMPANY L.L.C.	OMAN
PLATERS S.A	PERU
NEWAGE CABLES (PVT) LTD	PAKISTAN
ALASCO VINYL CORP	PHILIPPINES
POLYLINE INDUSTRIES	PHILIPPINES
QATAR PLASTIC ADDITIVES CO. (QADDCO)	QATAR
BARS-2	RUSSIA
DUNA LTD	RUSSIA
MASTER DEKOR COMPANY	RUSSIA
SARDONIX LTD	RUSSIA
AL-AYED GROUP INDUSTRY	SAUDI ARABIA
GREENLAND PLASTICS	SINGAPORE.MALAYSIA
SOUTH OCEAN ELECTRIC WIRE COMPANY	SOUTH AFRICA
PRESIDENT PLASTICS	SOUTH AFRICA
KAMAL PVC INDUSTRIES (PVT) LTD	SRI LANKA
ALRAGA FACTORY FOR PVC PIPES & FITTINGS	SUDAN
TOKATLI BROTHERS	SYRIA
SAAD PLAST CO.	SYRIA
FORMOSA PLASTIC (台塑,南亞,台化)	TAIWAN.CHINA
OCEAN PLASTICS CO., LTD	TAIWAN.CHINA
CHINA GENERAL PLASTIC CORP.	TAIWAN.CHINA
HERSHEY VALVE CO., LTD (鑽琪塑膠)	TAIWAN.CHINA
TATUNG CO (大同股份有限公司)	TAIWAN
財團法人鞋類暨運動休閒科技研發中心(鞋技中心)	TAIWAN
遠東新世紀股份有限公司	TAIWAN
VP PLASTIC PRODUCTS (1993) CO., LTD	THAILAND
BANGKOK PVC	THAILAND
DIAMOND BRAND CO.,LTD.	THAILAND
CLARIANT MASTERBATCHES	THAILAND,INDONESIA.TAIWAN.CHINA ETC
PAKPEN PLASTIC PIPE AND CONSTRUCTION MATERIAL	TURKEY
IDEAL PLASTIC MASTERBATCHES	TURKEY
ADOPEN PLASTIK SAN A.S.	TURKEY
BURPLAST BURSA PLASTIK SANAYI VE TICARET A.S.	TURKEY
FIRAT PLASTIK	TURKEY
INTEPLAST GROUP LTD	USA
CAMCO MANUFACTURING INC.	USA
JM EAGLE CO., INC	USA
SPEARS MANUFACTURING COMPANY	USA
RIF LTD	UKRAINE
INTERPLASTIC LTD /UKRPLASTIC	UKRAINE
TIENPHONG PLASTIC J/S CO.	VIETNAM
TIN KIM PLASTIC J/S CO.	VIETNAM
CHIN HUEI PLASTIC INDUSTRIAL CO., LTD	VIETNAM
ATOFINA VIETNAM	VIETNAM
BINH MINH PLASTICS J/S COMPANY	VIETNAM
FORTUNE ELECTRIC CORPORATION (NANOCO)	VIETNAM
NATIONAL CO.FOR SPONGE & PLASTIC INDUSTRY (NCSP)	YEMAN